

DeltaV™ MTP Merge Utility

- Easy Module Type Package (MTP) file integration
- Eliminate complex and expensive manual equipment integration operations
- Automated generation of OPC UA device interface, optimized signal mapping, and landing modules
- Easy management of equipment integration, updates, and documentation
- Seamless integration with Emerson's PAC Systems PLCs and AMS Asset Monitor
- Time-based licensing for optimized cost and greater flexibility

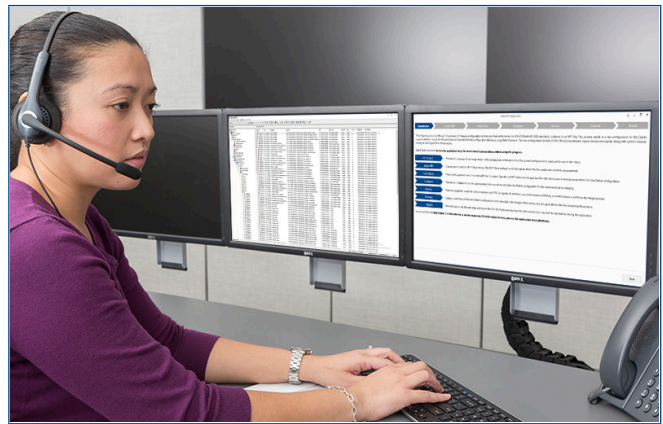

Introduction

Adding to a long history of best-in-class open standards data integration and contextualization, the DeltaV™ MTP Merge Utility provides an easy, guided, step-by-step interface for merging Module Type Packages (MTPs) into a DeltaV system. By utilizing the VDI/VDE/NAMUR 2658 standard to integrate autonomous process equipment, you can greatly reduce the risks associated with human error, changing requirements, multi-vendor coordination, and late project additions. MTP acts as a Project Certainty enabler by eliminating countless hours associated with the design, implementation, and testing of custom, vendor-specific interfaces by leveraging the easy, fast, and flexible MTP based DeltaV configuration experience.

Benefits

Easy MTP File Integration

With the introduction of the MTP Merge Utility into the DeltaV engineering environment, many of the complications associated with equipment integration have been eliminated. A new software application dedicated to the integration management of MTP files has been created. There is no need to create your own tools for managing MTP files and you no longer need to manage how those configurations will interact with your DeltaV system. The MTP Merge Utility allows you to view the contents of the MTP you are planning to import and easily select the components of it that you would like to integrate with your DeltaV system

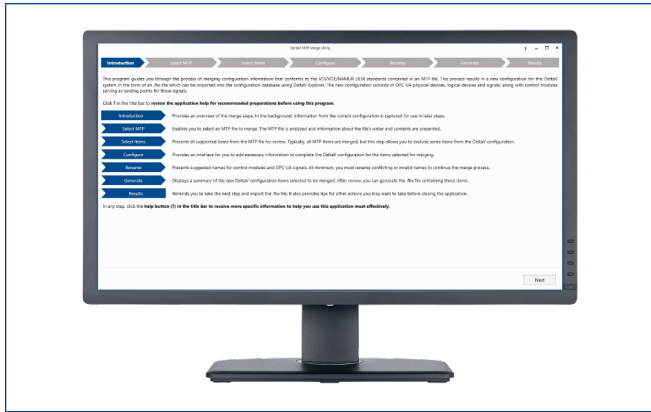

Eliminate complex and expensive manual equipment integration operations

Take the ambiguity and stress out of your PLC integration by using the tightly integrated MTP Merge configuration application. Since MTP is a vendor neutral interface specification that defines all the necessary parameters to establish communication between a DCS and a PLC based process unit, there is no longer a need to maintain complex data mapping spreadsheets, no need to drive costly coordination between site personnel, various OEM equipment suppliers, and project integrators, and no need to conduct prototyping as package equipment can be validated along with its MTP file prior to its integration into DeltaV.

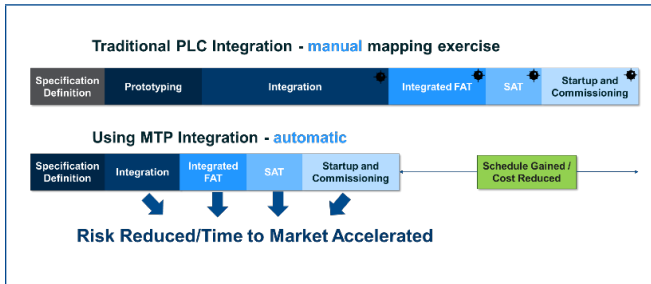

Benefits of MTP. Schedule management and cost control using MTP-based integration workflows

Automatic generation of OPC UA device interface, optimized signal mapping, and landing module configuration

Eliminate engineering time, reduce risk and integration costs, and increase quality by removing manual configuration activities. The DeltaV MTP Merge Utility will automatically convert your MTP-based configuration into a DeltaV control strategy. All the relevant OPC UA interface properties, an optimized mapping of the OPC UA signals (to reduce DST consumption), and landing control modules are all generated

quickly and automatically making what used to be a complex process simple, error free, and optimized for minimal system integration licensing impacts.

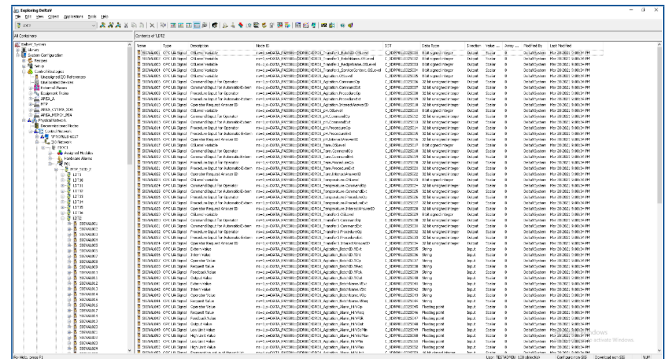

Optimized Configuration Generation. DeltaV Explorer showing the creation of automated and optimized OPC UA signal mapping.

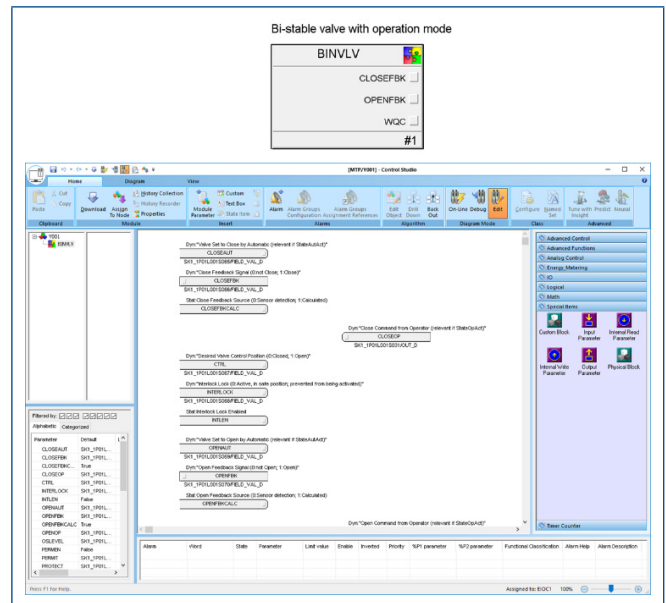

MTP Data Context. DeltaV Control Studio showing the creation of automated landing control modules for use in control strategies and operator displays.

Automatic name conflict identification and resolution

One of the most difficult aspects of equipment integration is ensuring that the newly added configuration does not negatively interact or impact the existing system. Since the DeltaV MTP Merge Utility is a native DeltaV application, it has connections directly into the active DeltaV configuration database. This allows for highly optimized configuration management by providing the integration engineer instantaneous feedback – through the form of live Status indications about configuration and naming conflicts - about how their merged configuration will interact with the production system database. Any error conditions that are identified can be immediately reconciled through powerful editing features built directly into the application.

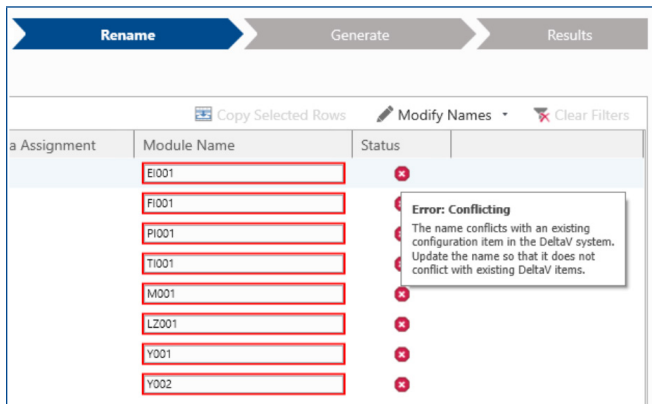

Native Conflict Resolution. MTP Merge Utility showing live feedback for landing control module naming conflicts.

Easy management of equipment integration, updates, and documentation

Although it is expected that MTP based workflows will eliminate the need to conduct prototyping, as package unit equipment can be pre-validated along with its MTP file prior to its integration into DeltaV, it is understood that this is not always the case. No matter how well managed a system design or equipment sourcing may be, there are always scenarios where late changes must be made.

MTP Merge Utility makes this easy by allowing the configuration engineers the opportunity to save their MTP processing selections and modifications (via an .mtpc file), to either work on them later or to apply them to a newer version of the vendor supplied MTP file. The pains of reconciling late stage changes are reduced without adding any risk.

Another powerful feature built into the MTP Merge Utility is the ability to extract configuration import selection choices, module naming, and tag naming records to external applications. MTP Merge allows for the grid contents to be copied out in .CSV format and saved to a variety of external applications for accurate record keeping or sharing of configuration decisions.

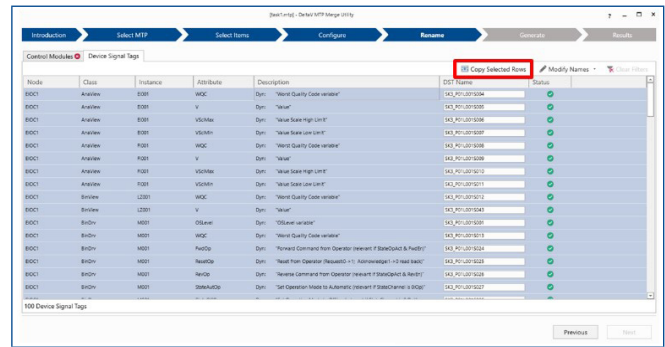

Easy Data Extraction. MTP Merge Utility showing selection and copying of DST renaming grid.

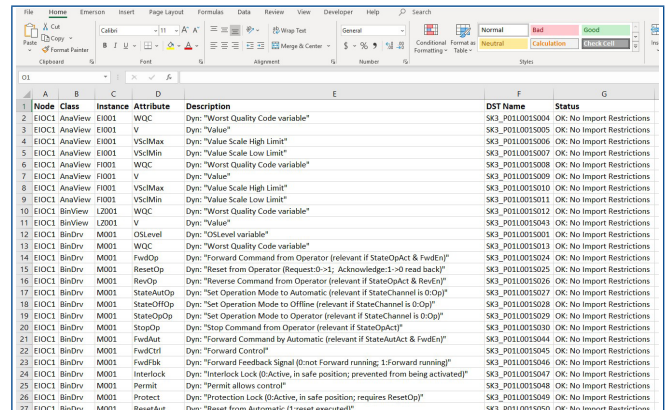

Simplified Record Keeping. MTP Merge Utility showing selection and copying of DST renaming grid.

Seamless integration with Emerson’s PAC Systems PLCs and AMS Asset Monitor

MTP is an evolving standard. At the time of this document’s publication , only 3 parts of the full 12-part MTP standard have been ratified. And even though MTP is a vendor neutral interface specification, there exists no certifying body for MTP file generation and file consumption applications. Because of this, there is room for interpretation of the standards. This means that the early stages of MTP proliferation will likely involve some integration issues as the technology advances and standards are refined.

As MTP evolves, organizations can benefit from Emerson's foundation of interoperability between Machine Automation Solutions PACSystems' PLCs, Reliability Solutions Machinery Health and Prediction AMS Asset Monitor, and DeltaV products. Emerson's support for MTP will help plants prepare for the increased flexibility that is on the horizon while still ensuring standards for interoperability between pre-tested systems with higher security and a single point of support for issue resolution.

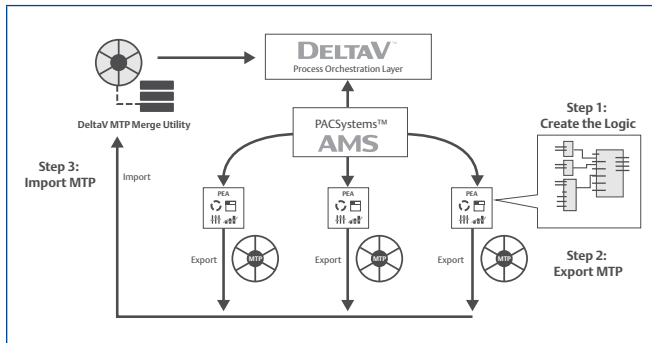

MTP Workflow. Diagram depicting the full MTP file integration workflow.

Time-based licensing for optimized cost and greater flexibility

The dynamic engineering needs encountered when integrating skid-based equipment during modular plant projects, Factory Acceptance Tests (FAT), Site Acceptance Tests (SAT), plant startups & commissioning activities, turnarounds, and plant expansions can be satisfied with flexible, time-based DeltaV Engineering Seats. The DeltaV MTP Merge Utility leverages the DeltaV Floating License mechanism to offer optimized engineering capacity to address the periods of peak engineering demand. Only purchase the number of seats and the time period required for engineering – no waste.

Product Description

Leveraging the design and workflow of the DeltaV PK Merge Utility, an application developed for optimizing standalone process skid integration with DeltaV, the DeltaV MTP Merge Utility provides a wizard-like experience for configuration engineers to select, modify, and import auto-generated DeltaV control strategies based on standard MTP files into their DeltaV configuration databases.

MTP Merge Utility Workflow

The following sections describe the key steps designed to optimize the configuration engineer's workflow for importing MTP files into their DeltaV system configuration database.

Select MTP

The Select MTP step allows a user to select an MTP provided by the skid vendor, package unit configuration engineer (.mtp or .zip format), or to select a saved MTP merge choices configuration file (.mtpc format) to be merged into their DeltaV system. The selected MTP file is loaded, analyzed, and information about the file's writer, a summary of its contents, and any informational, warning, or error messages associated to its processing are presented to the user.

Select Items

The Select Items step presents all currently supported items from the selected MTP file for review. The data presented on this step is displayed on two tabs, the Data Assembly Instances and Attributes tabs. The current version of the MTP Merge Utility has support for VDI/VDE/NAMUR 2658 Parts 1 and 3*. The Data Assembly Instances tab lists all the data assembly instances found in the MTP file loaded in the previous step. The Attributes tab lists all the attributes that the OPC UA servers in the MTP can supply to the DeltaV system as OPC UA signals. MTP attributes, when merged into the DeltaV configuration, become OPC UA signals and corresponding parameters in landing modules.

Typically, all discovered MTP items are merged and are selected by default, but this step allows the configuration engineer to exclude items from the eventual DeltaV configuration.

Configure

The Configure step provides an interface for the configuration engineer to add necessary information for the transition to their desired DeltaV configuration for the items which were selected in the previous step. The information presented on this step is displayed on two tabs, the Control Modules and OPC UA Clients tabs. The content on these tabs is used to set the DeltaV properties for transformed MTP Data Assembly instances, to assign the new items to DeltaV areas, nodes and OPC UA Client physical devices.

*DeltaV does not currently have support for all data types defined in the MTP Part 3 specification. For example, OPC UA Clients in DeltaV support String reads but not writes, 64-bit data types are not supported, etc. Please reference the MTP Merge application help for additional details.

The Control Modules tab lists all the data assembly instances that you selected on the Select Items page. At the end of the merge process, the utility will create a landing module for each instance. The OPC UA Clients tab lists the OPC UA Servers that require a DeltaV Node Assignment and the name of the DeltaV Physical Device that will be imported into DeltaV to represent the OPC UA Server.

Rename

The Rename step presents suggested names for control modules and OPC UA Signals as they will appear in the DeltaV configuration database. The information on this step is also shown in a tabular view with two tabs, the Control Modules and Device Signal Tags tabs. This step should be used to address any DeltaV configuration naming or renaming (e.g. addressing naming conflicts or duplications) that you would like to perform prior to loading your configuration into DeltaV. At a minimum, you must resolve all Error conditions (conflicting or invalid names) before moving forward in the merge process.

Generate

The Generate step displays a summary of the new DeltaV configuration items that were selected for merge. After reviewing the statistics to ensure they align with the configuration engineers' expectations, a DeltaV configuration .fhx file can be generated containing those items. The .fhx file can then be imported into the desired DeltaV configuration database.

Additional Functionality

Write Control Arbitration - OSLevel

The VDI/VDE/NAMUR 2658 Part 3 specification (section 7.3) defines a mechanism to coordinate several elements of the system in operating a Process Equipment Assembly (PEA, e.g. "a skid"). This mechanism allows a skid with a local HMI to at times have exclusive operation control of the skid, excluding operation (writes) from a Process Orchestration Layer element (POL, e.g. a DeltaV system communicating with the skid's OPC UA Server), and vice versa.

Data Assembly Instances that can participate in this mechanism have a (writable) Attribute named OSLevel, a signed 8-bit

integer, whose value determines what system element should be allowed to write to Attributes in the Instance (i.e. write to OPC UA Signals referenced in DeltaV landing Modules):

- While the value of OSLevel (a Parameter in a DeltaV landing Module) is 0, manual operation is only permitted via on-site operation (e.g. a local HMI panel on the skid.)
- While the value of OSLevel is greater than 0, manual operation is only allowed from the POL (e.g. the DeltaV system)

If operation coordination based on OSLevel values is desired, there is an option to set this value during the MTP merge configuration process.

Bulk Name Modification

To support accelerated integration activities the Rename step has support for bulk name modification through the introduction of a powerful Modify Names tool. The tool allows a configuration engineer to perform find and replace of common characters or strings, to add a prefix or suffix to suggested names, and even to assign bulk name creation for alignment with site-specific naming standards.

Save and Restore Configuration

The MTP Merge Utility supports saving and restoring of the MTP merge choices through the generation of merge choices configuration files (.mtpc). These are files that contain saved user-selections, configuration options, parameter renaming, etc. from an MTP merge processing session. These files can be extremely useful if managing incremental late-stage skid configuration changes as mentioned in the Easily manage equipment integration, updates, and documentation section of this document.

Easily Extract Processed MTP Content

The MTP Merge Utility allows for the contents of any of the data grids used throughout the application experience to be copied out in a .CSV format and pasted into any external software application (e.g. MS Excel). Also, all file processing and generation reports (potentially containing informational, warning, or error messages) can be easily copied out of the application for use in correspondence with skid suppliers.

Application Usage Considerations

MTP Merge Utility engineering environment

The MTP Merge Utility will be available as a native DeltaV engineering application as part of the v14 Feature Pack 2 (v14.FP2) release and later.

As the MTP Merge Utility has direct connections to the active DeltaV configuration database to provide live comparison results, it will only be installed on and be able to run on the ProfessionalPLUS workstation.

When using the MTP Merge Utility licensing, keep in mind that the licenses can float between Remote Client users and if more than one simultaneous user needs to access this application, multiple licenses can be applied to the ProfessionalPLUS to allow more than one Remote Client session in parallel.

Time-based License Options

All MTP Merge application licenses are offered as a time-based expiring license. The license duration begins on the license creation date (21 days are added to the license duration to account for processing time, possible delays in customer schedule, or access to the system on which to install the license). Licenses cannot be extended beyond the configured expiration date; a new license must be purchased if more time is required. Licenses are managed by the DeltaV Floating License Manager as described in the DeltaV Engineering Seat Software Suite Product Data Sheet.

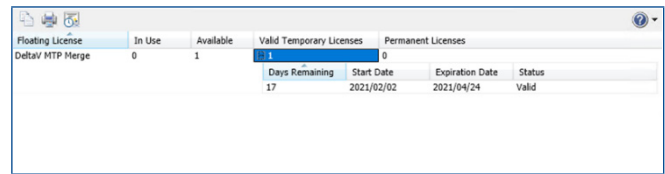

License Management. DeltaV Floating License Manager showing the use of time-based MTP Merge application licenses.

Software Ordering Information

Description	Model Number
DeltaV MTP Merge, 6-month license	VE2166T06
DeltaV MTP Merge, 12-month license	VE2166T12
DeltaV MTP Merge, 24-month license	VE2166T24
DeltaV Simulate Multi-node MTP Merge, 6-month license	VX2166S01T06
DeltaV Simulate Multi-node MTP Merge, 12-month license	VX2166S01T12
DeltaV Simulate Multi-node MTP Merge, 24-month license	VX2166S01T24
DeltaV Discovery MTP Merge, 6-month license	VXD2166S01T06
DeltaV Discovery MTP Merge, 12-month license	VXD2166S01T12
DeltaV Discovery MTP Merge, 24-month license	VXD2166S01T24

The above mentioned VE (DeltaV MTP Merge 6, 12 and 24 month) Licenses can be ordered for use with DeltaV Production systems and DeltaV Simulate Standalone systems.

Related Products

- ProfessionalPLUS Station Software Suite
- Ethernet I/O Card (EIOC)
- DeltaV OPC UA Servers and Clients
- DeltaV Engineering Seat Software Suite
- PAC Machine Edition - Integrated Software for PACSystems Devices
- Online Prediction, Protection and Process Monitor
- AMS Asset Monitor Asset Source Interface

Prerequisites

- The DeltaV MTP Merge Utility requires DeltaV software version 14.FP2 or newer.
- Your DeltaV system must contain an OPC UA Client interface (ProfessionalPLUS, Application Station, or EIOC) prior to being able to perform MTP based integrations.

©2023, Emerson. All rights reserved.

The Emerson logo is a trademark and service mark of Emerson Electric Co. The DeltaV logo is a mark of one of the Emerson family of companies. All other marks are the property of their respective owners.

The contents of this publication are presented for informational purposes only, and while diligent efforts were made to ensure their accuracy, they are not to be construed as warranties or guarantees, express or implied, regarding the products or services described herein or their use or applicability. All sales are governed by our terms and conditions, which are available on request. We reserve the right to modify or improve the designs or specifications of our products at any time without notice.

Contact Us

www.emerson.com/contactus