

AMS 6500 Machinery Health™ Monitor Chassis Options

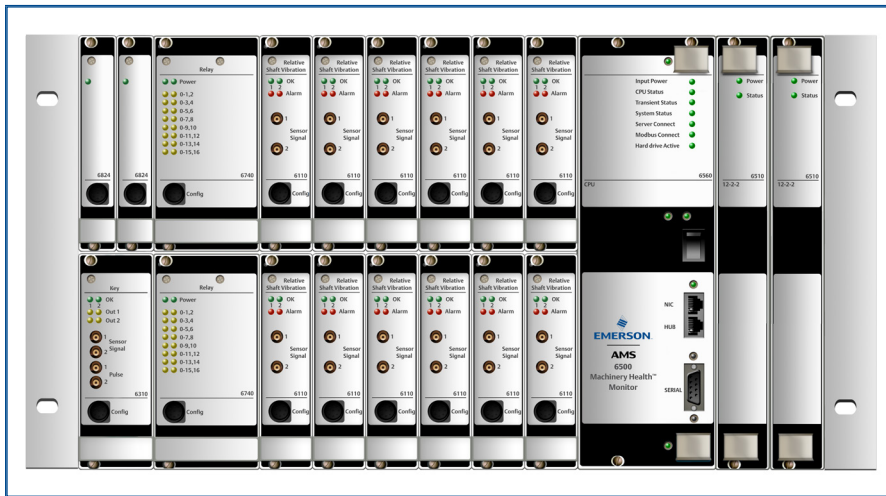

The AMS 6500, AMS software, DeltaV, and Ovation provide a complete solution for critical rotating machines that includes protection, prediction, and performance.

The AMS 6500 Machinery Health Monitor, fully compliant with API 670 and API 618, protects and monitors critical rotating machinery.

Unique abilities include easy three-step integration of protection information with the DeltaV™ and Ovation™ process automation systems, transient analysis for turbomachinery including live, record, pause and replay, and awardwinning PeakVue processing for early warning of faults in rolling element bearings and gears.

Chassis configurations include:

- 19" wide protection only chassis includes both a 6U and the industry's only 3U high version.
- 19" wide prediction only chassis is 6U high with either front sensor terminations or rear sensor terminations. Additionally a compact 7.5" wide version is available.
- For combined protection monitoring and predictive monitoring, all chassis are 19" wide and 6U high.

- Fully API 670 and API 618 compliant with machinery health monitoring
- Design ensures that a single circuit failure will not affect more than two channels, including hot swappable module replacement
- Internal timeclock synchronization with plant time included
- Redundant Modbus, TCP or serial, for integration of protection monitors with 3rd party control systems. Additional simplex Modbus output for prediction parameters
- Slots for 16 or 32 shutdown relay outputs
- Two-channel tachometer/key channels
- 12 slots for 3U high two-channel vibration and position monitoring modules for a total of 24 inputs
- 4-20mA outputs and buffered outputs rear and front
- Includes relay bypass and trip multiply configurable per channel
- Power supply external and does not require chassis slot

AMS 6500 Configurations

Chassis Options	API 670 Protection	Rolling Elements & Gears	Transient for Turbo-machinery	Rear Sensor Terminations	Front Sensor Terminations	Small Chassis Size
A6500 PT	✓	✓	✓	✓		
A6500PM	✓	✓		✓		
A6500P-24* <i>*Upgradable to Machinery Health Monitoring</i>	✓			✓		
IMR600010	✓			✓		✓
IMR600020	✓			✓		✓
IMR600030	✓			✓		✓
A6500MF		✓			✓	
A6500TF		✓	✓		✓	
A6500MR		✓		✓		
A6500TR		✓	✓	✓		
A6500MS		✓		✓		✓
A6500TS		✓	✓	✓		✓

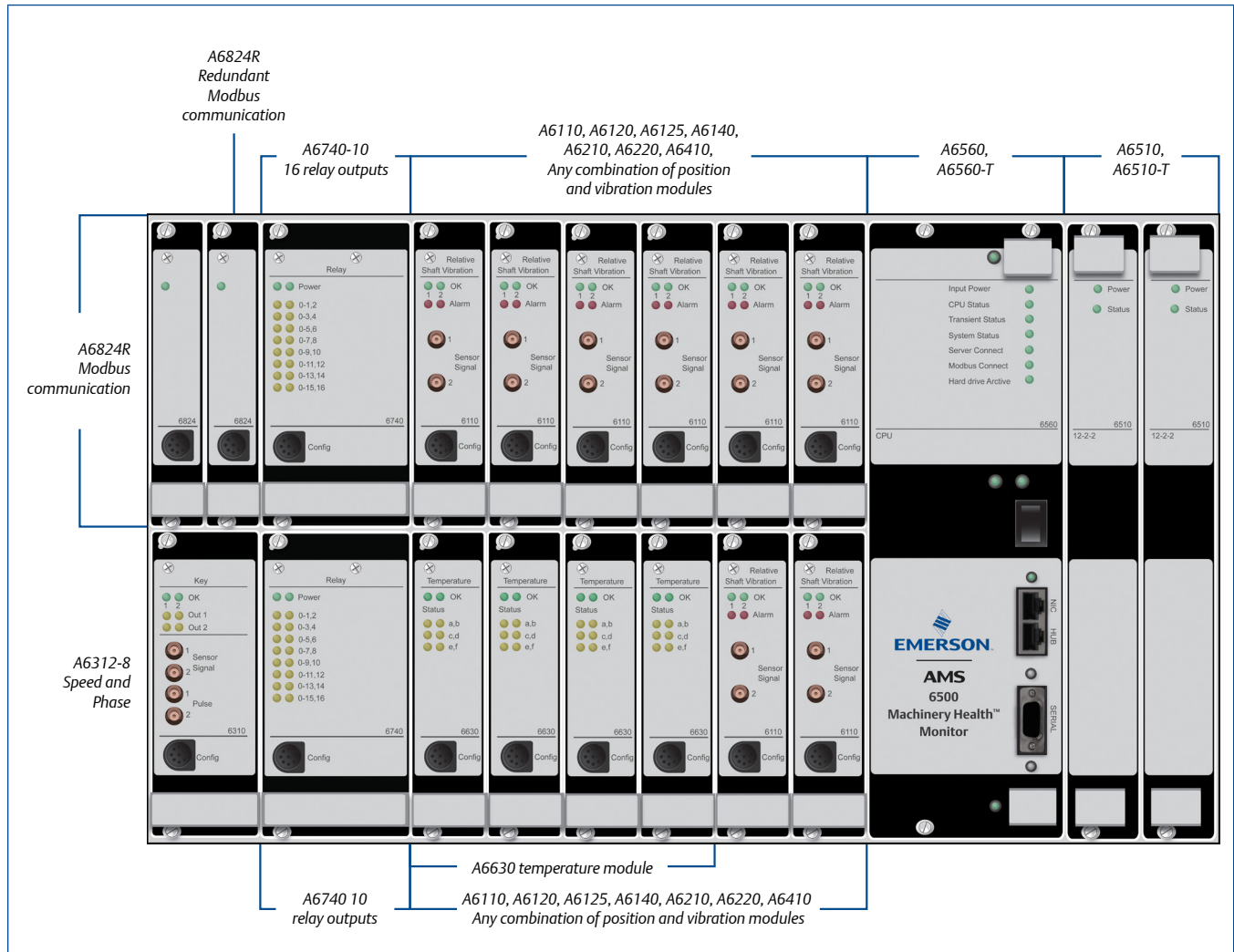

Module configurations for protection and transient monitoring for turbomachinery, A6500PT, and module configurations for protection and machinery health monitoring for rolling elements and gearboxes, A6500PM.

Specifications

General System Specifications	
Environmental	
A6560, A6510	-17° to 65°C (0 to 150°F)* 0 - 95% R.H. noncondensing
A6560-T	-17° to 65°C (0 to 150°F)* 0 - 50% R.H. noncondensing
A6510-T	-17° to 55°C (0 to 130°F)* 0 - 95% R.H. noncondensing
Ratings	CE EN50081-2 Emissions noncondensing CE EN50081-2 Emissions CSA (Pending)
Power	
Chassis Input	18 VDC to 31 VDC (24 VDC Nominal)
Maximum Input Surge	7 ADC @ 24 VDC for 1 msec 3 ADC @ 24 VDC for 20 msec
Maximum Power Dissipation	6 W for each protection module, 5 W for Modbus module, 22 W for full set of prediction modules and 33 W for full set of transient modules. (Please see individual spec sheets for additional specifications.)

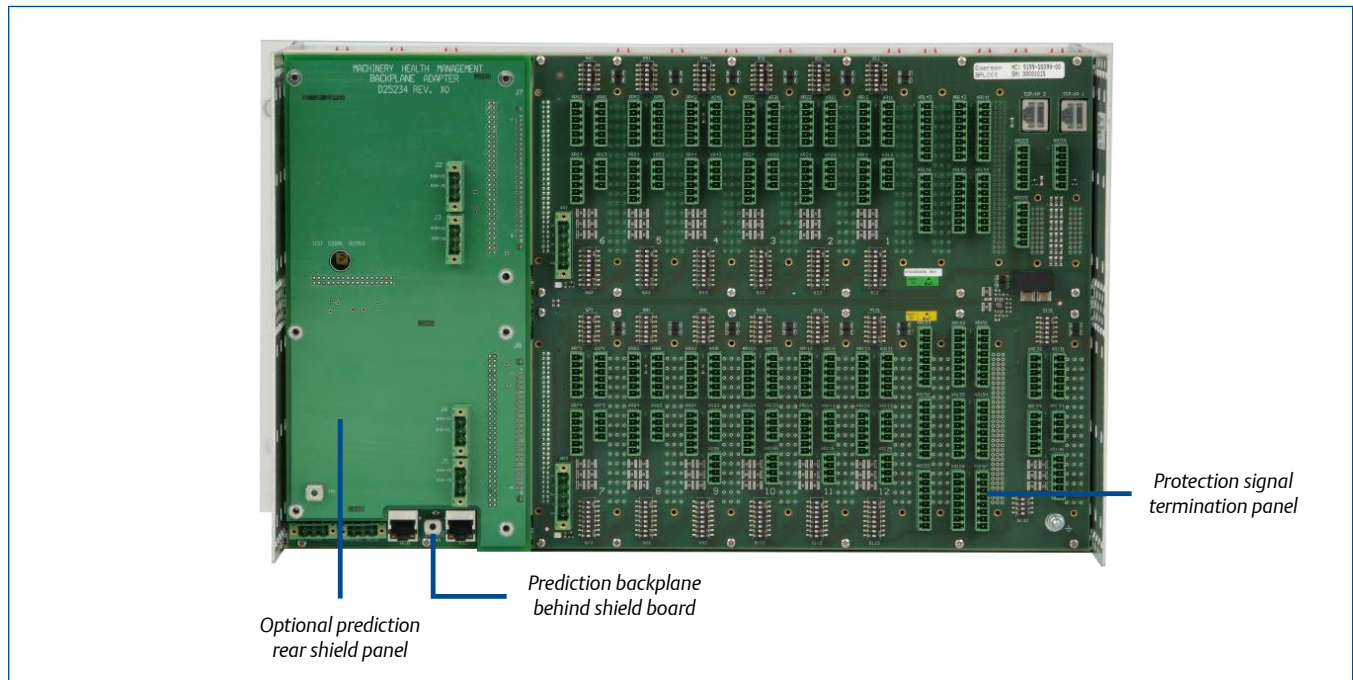

Rear side of the A6500PT, A6500PM Machinery Health Monitor. Shown with rear shield panel. If the optional dual termination panel is ordered, the dual termination panel will replace the shield panel shown above.

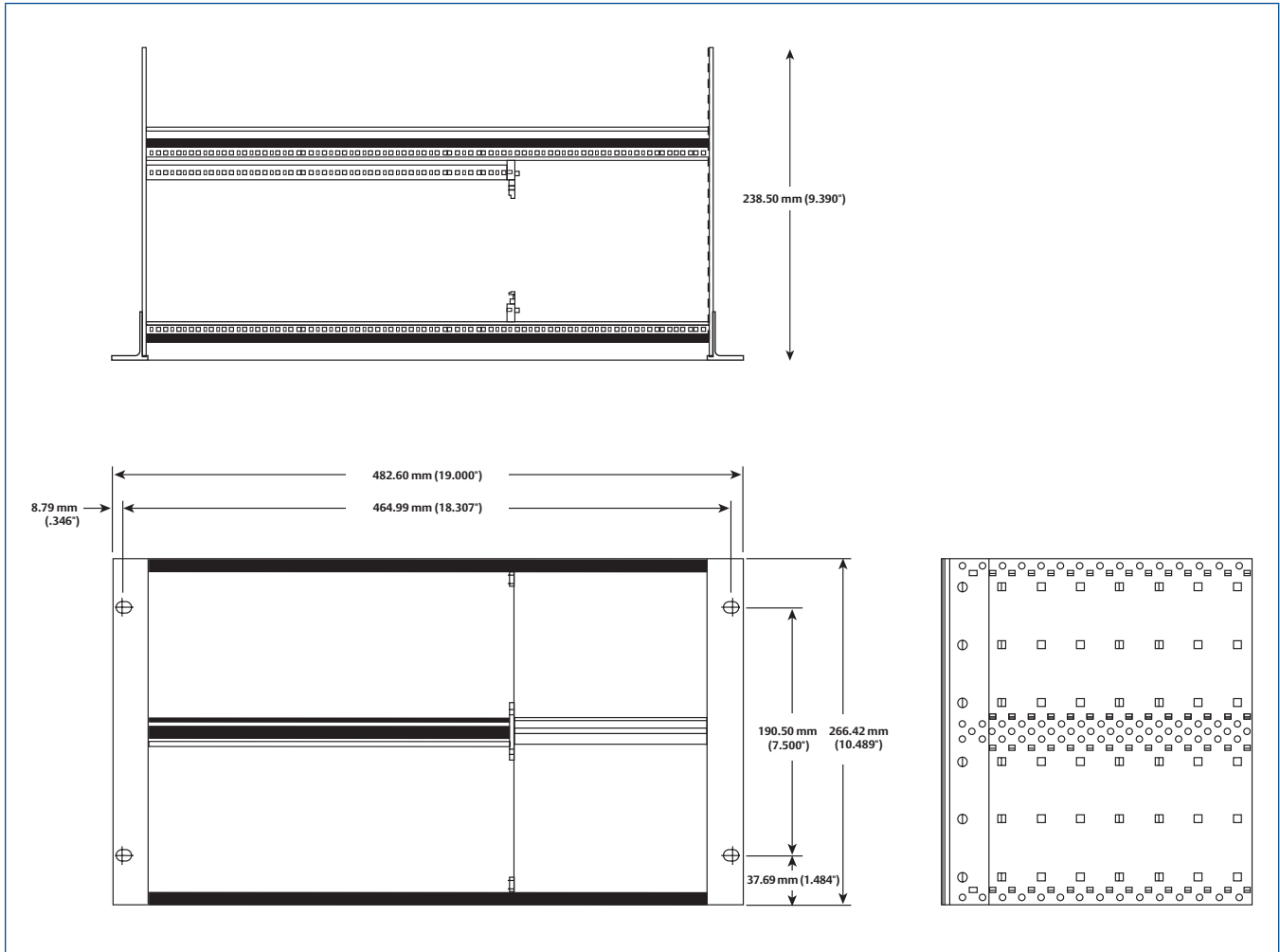

Note: Dimensions in inches for part numbers A6500PT, A6500PM, A6500P-24, A6500MR, A6500TR, A6500MF, and A6500TF. Chassis part number with splitting kit for combined machinery health and protection monitoring, MHM-85733.

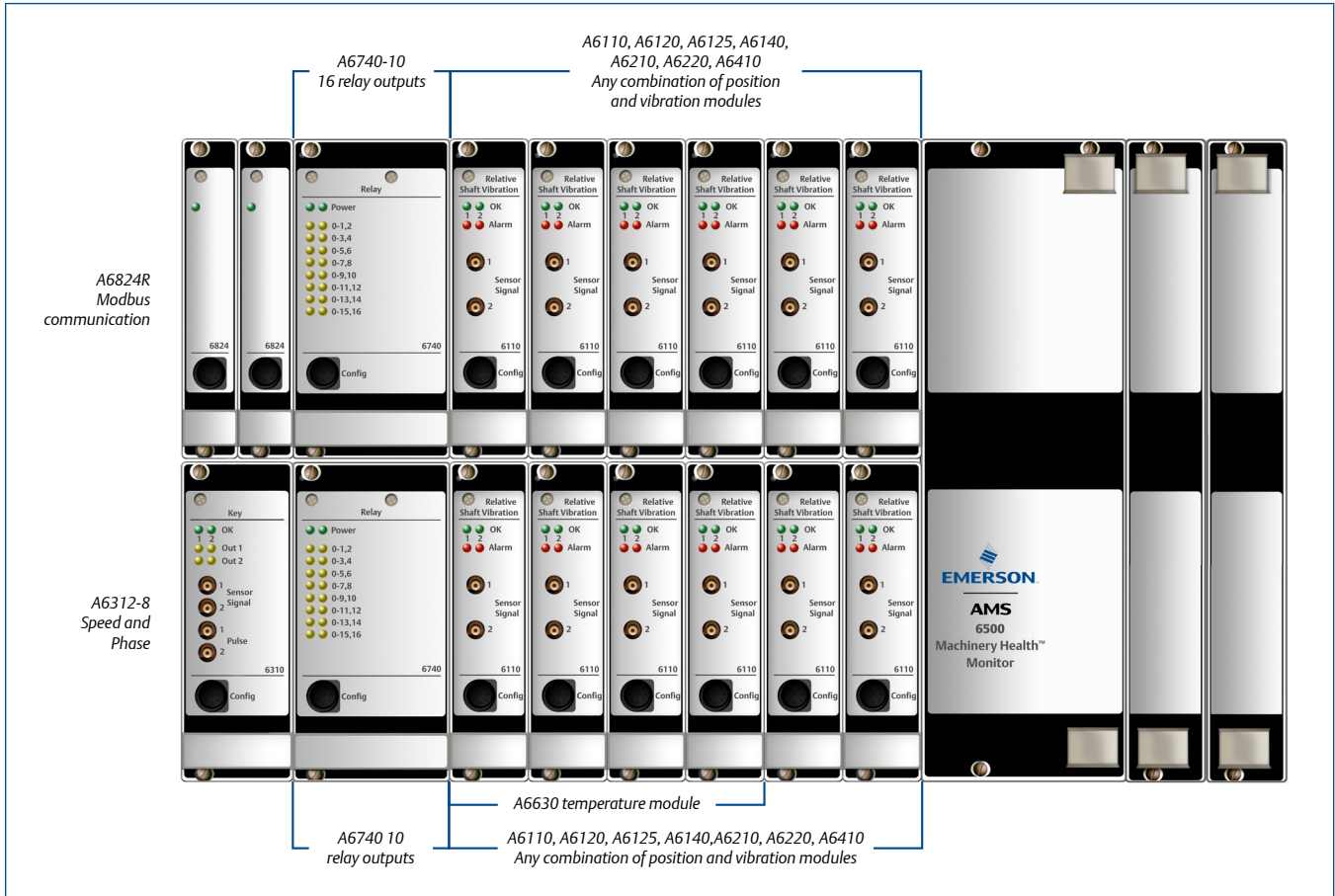

Module configurations for protection only in a 6U high chassis by 19" wide. Upgradable to prediction.

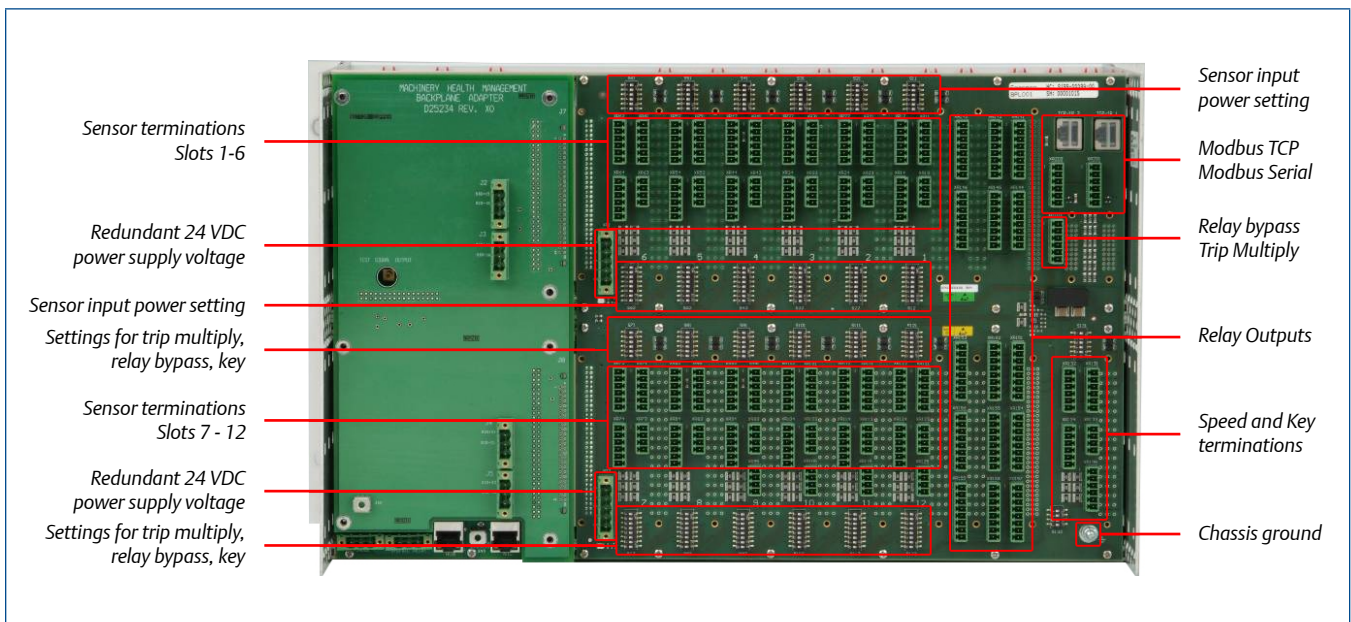

Rear view of A6500P-24, the machinery protection inputs and outputs.

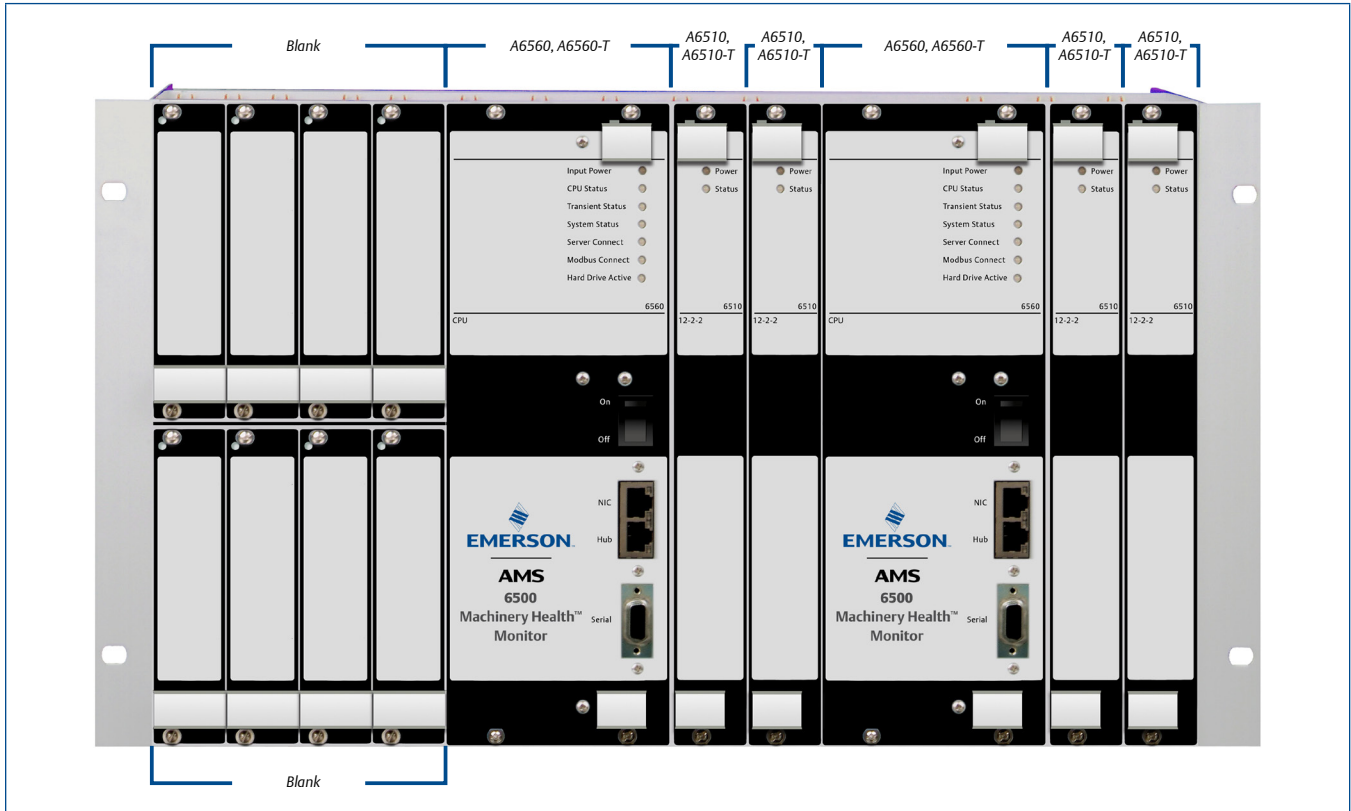

Choose A6500TR-36, A6500TR-48, A6500MR-36, A6500RM-48 for high channel count, rear sensor termination prediction only solutions.

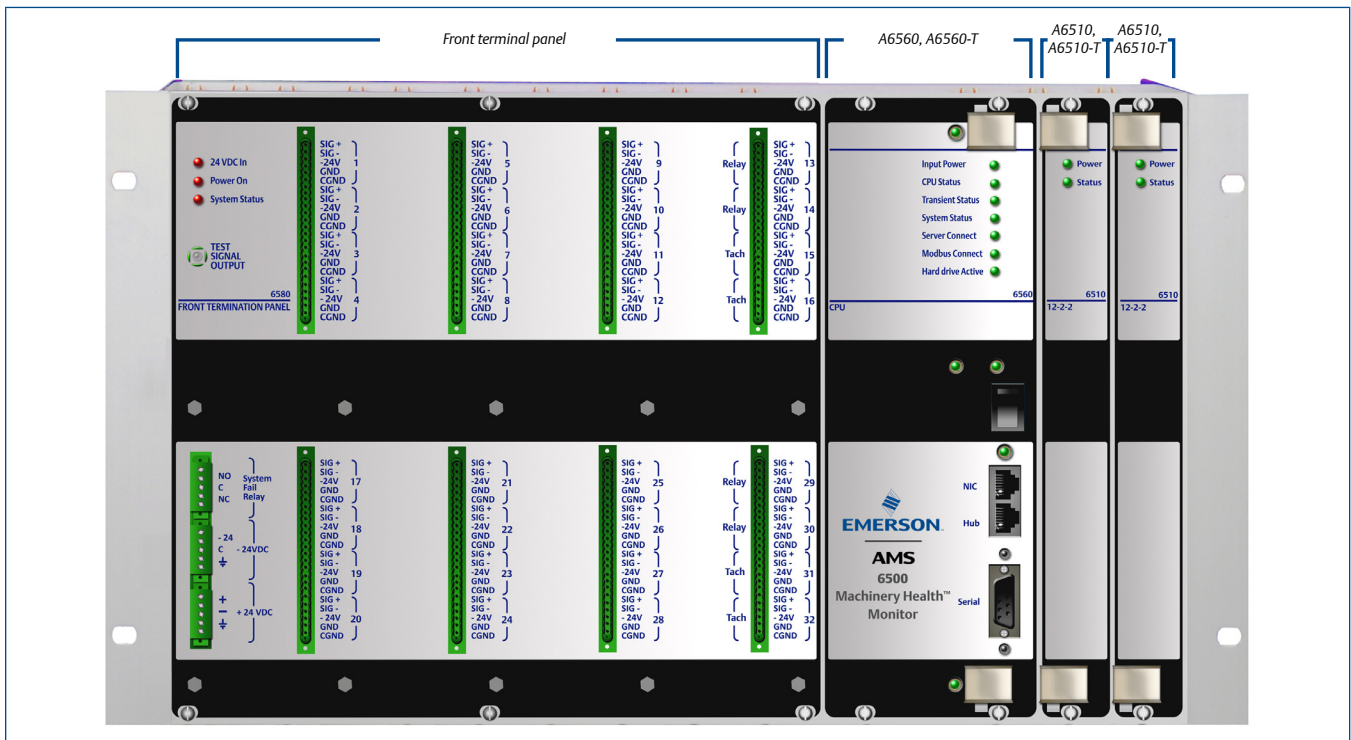

Choose A6500TF-12, A6500TF-24, A6500MF-12, A6500MF-24 for 19" by 6U high wall mount enclosure or front sensor termination prediction-only solutions.

Monitoring Modules	
Protection Modules	
A6110	Shaft relative vibration 9199-00001
A6120	Case, seismic vibration 9199-00002
A6125	Case, piezo (accelerometer) vibration 9199-00069
A6140	Shaft absolute vibration 9199-00058
A6210	Thrust, differential expansion, and rod drop 9199-00003
A6220	Shaft eccentricity 9199-00009
A6312	Speed / key (6HP) 9199-00025
A6312-8	Speed / Key (8HP) 9199-00024
A6410	Valve / case expansion 9199-00005
A6620	4-20mA process input 9199-00086
A6630	RTD and thermocouple input
A6740	16 channel relay (12HP) 9199-00035
A6740-10	16 channel relay (10HP) 9199-00091
A6824	Modbus communication (6HP) 9199-00090
A6824R	Modbus communication (4HP), redundant optional 9199-00098
Prediction Modules	
A6510	12-2-2 Machinery Health signal input
A6510-T	12-2-2 Machinery Health signal input, with transient option
A6560	Machinery Health processor for up to 24 channels
A6560-T	Machinery Health processor for up to 24 channels, transient option

Optional Items	
Part Number	
A476514	PeakVue for Machinery Health processor A6560 or A6560T (up to 24 channels)
A476520	Modbus for Machinery Health processor A6560 or A6560T (up to 24 channels)
A6068	Redundant power supply, 100 – 240 VAC input, 24 VDC output
MHM-93301	Single power supply
MHM-6xxx-SMBADTR	SMB to BNC adapters
MHM-6xxx-SMBCABLE	SMB to SMB signal output cable
A6910	AMS 6500 protection module configuration software
D25225	A6560 slot blank panel
D25216	A6510 slot blank panel
MHM-85708	6 HP wide protection slot blank panel
MHM-85730	24 HP wide protection slot blank panel
A6500-SS-ENCL	Wall mount enclosure for front termination AMS 6500, A6500MF and A6500TF
MHM-85733	Splitting kit (required only to upgrade a prediction-only configuration to include protection)
A6500-M-BP	Machinery Health backplane
A6500-RSH	Rear sensor shield panel for prediction
A6500-M-RTRM	Dual rear termination panel and rear sensor termination for prediction

3U Height Chassis Options

The 3U height chassis option is perfect for applications where space is an issue, protection only is required, or only a few monitoring modules are required.

Three chassis configurations offer flexibility for:

- standard, protection only
- protection only, with high relay count
- process input rack such as temperature monitoring

Specifications for IMR6000:



Dimensions:
according to IEC 60297-3 / DIN 41494,
Part 3

- Width: 19" (482.6 mm)
- Height: 3 HE (132.5 mm) (5.22")
- Width(frame inside):
- 84 TE (426.72 mm) (16.8")
- Mounting depth: 211 mm (8.31")
- Material: Aluminum
- Surface: Anodized Aluminum
- Surface: Anodized Aluminum
- Accessories: 10 pairs of isolated
guide rails
- Weight: Approximately 2.0 kg
(4.41 lbs.)

Side view:

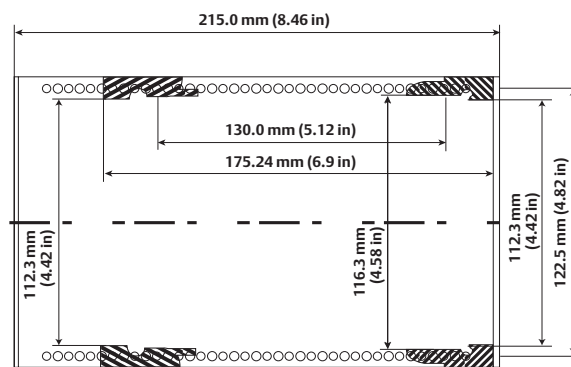

- 19" wide chassis for standard cabinet mount
- QQ The industry's only 3U high monitoring modules offers more flexibility for installations

Figure 1
All dimensions
in mm (inches)

Front view:

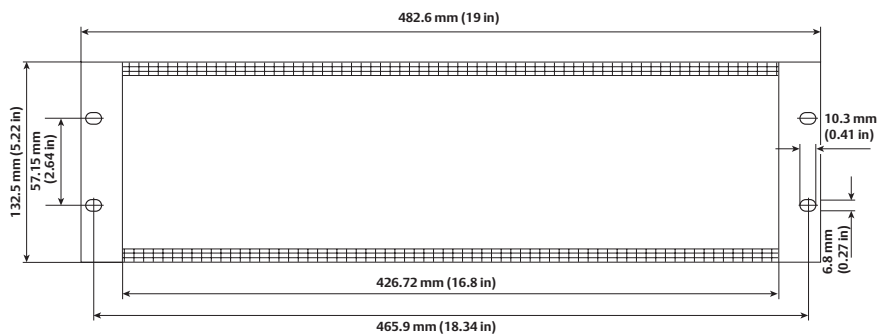
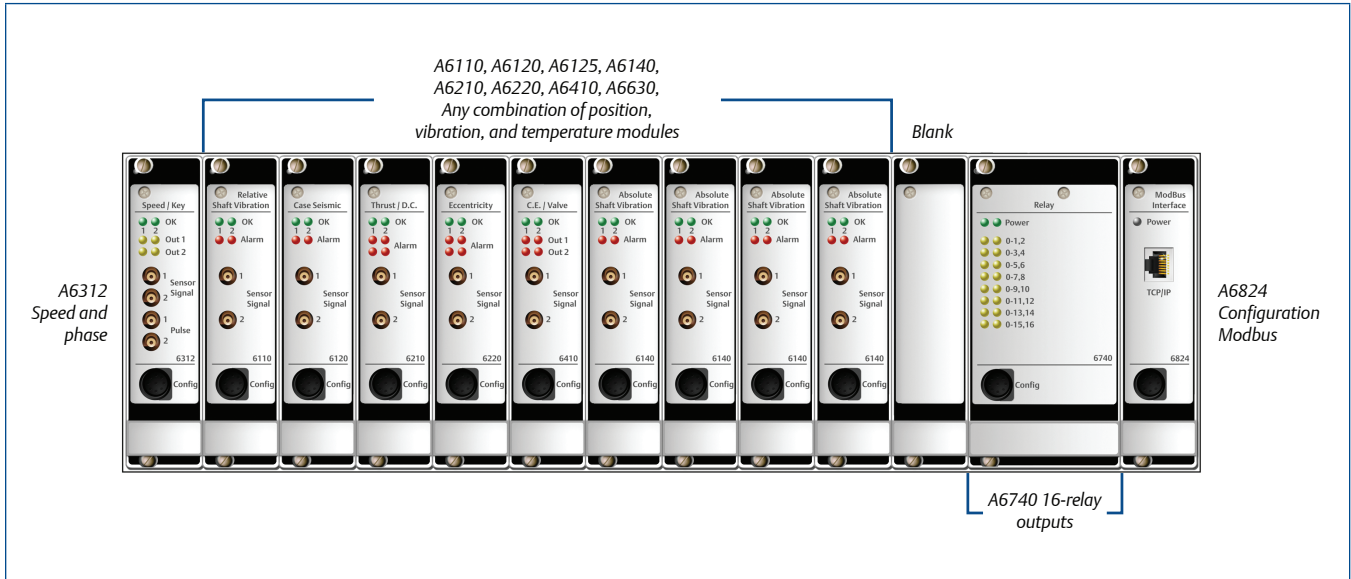
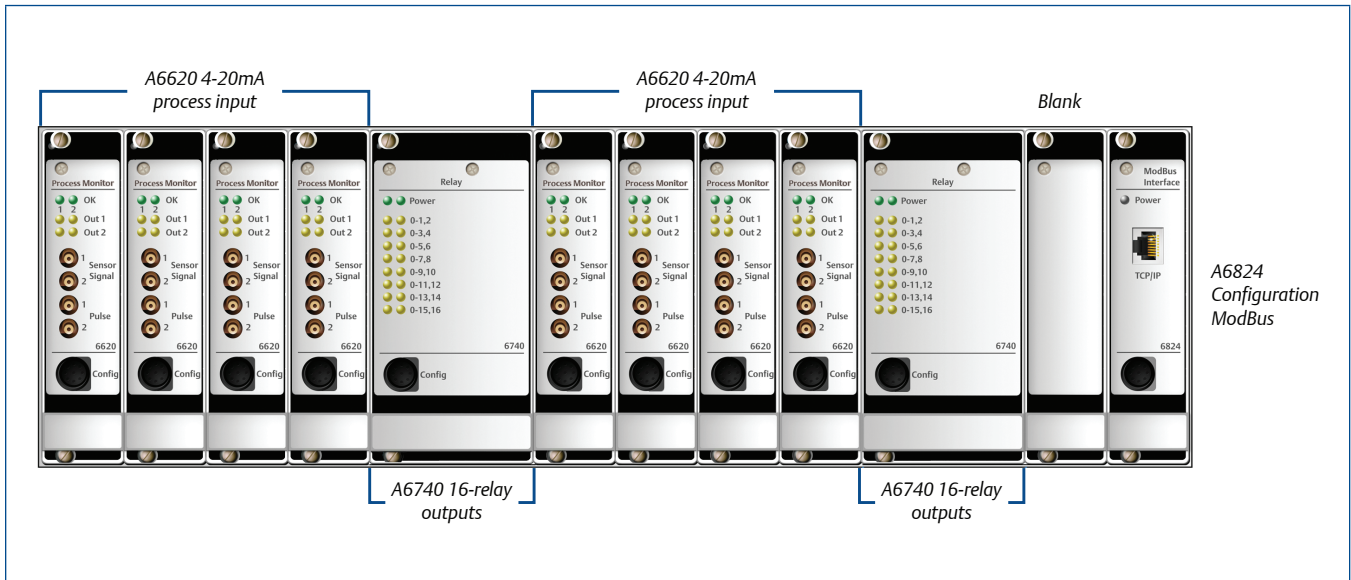

Figure 2
All dimensions
in mm (inches)



IMR600010 3U high by 19" wide, protection only solution capable of 16 relay outputs.



IMR600020 3U high by 19" wide, process input, protection only solution capable of 32 relay outputs.

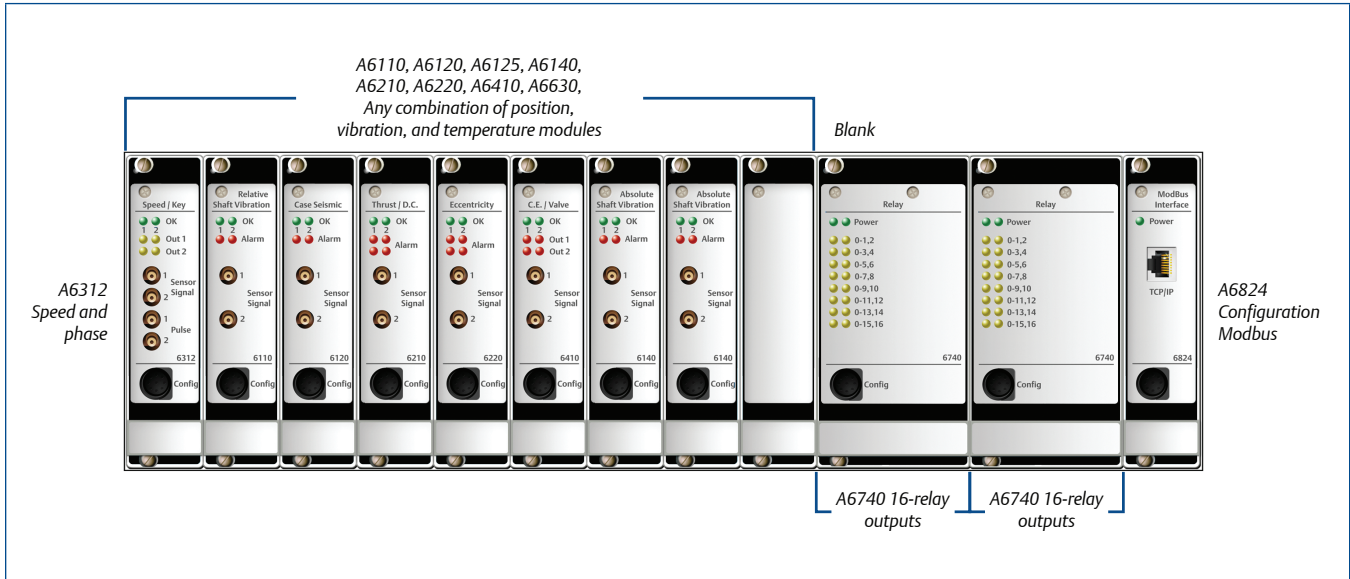

IMR600030 3U high by 19" wide, protection only solution capable of 32 relay outputs.

Ordering Information

Model Number	Product Description
IMR 011	19", 14 slot card cage only, no backplane
IMR600010	Standard 14 Slot Rack, 19" Rack. Slot configuration: 1 Tach module, 9 Vibration, Position, or Temperature modules, 1 Blank, 1 (two slot wide) Relay module, 1 Communication module
IMR600020	Process Input Rack, 14 Slot Rack, 19" Rack. Slot configuration: 8 Process input modules, 2 (two slot wide) Relay modules, 1 Blank, 1 Communication module
IMR600030	Standard rack, but with twice the relay output capability: 14 Slot, 19" Rack. Slot configuration: 1 Tach module, 7 Vibration, Position, or Temperature modules, 1 Blank, 2 (two slot wide) Relay modules, 1 Communication module

Specifications

General System Specifications	
Environmental	
A6500MS-12	0 to 150°F (-17° to 65°C)* 0 - 95% R.H. noncondensing
A6500MS-24	0 to 150°F (-17° to 65°C)* 0 - 95% R.H. noncondensing
A6500TS-12	0 to 150°F (-17° to 65°C)* 0 - 50% R.H. noncondensing or 0 to 130°F (-17° to 55°C)* 0 - 95% R.H. noncondensing
A6500MS-24	0 to 150°F (-17° to 65°C)* 0 - 50% R.H. noncondensing or 0 to 130°F (-17° to 55°C)* 0 - 95% R.H. noncondensing
Ratings	CE EN50081-2 Emissions noncondensing CE EN50081-2 Emissions CSA (Pending)
Power	
Chassis Input	18 VDC to 31 VDC (24 VDC Nominal)
Maximum Input Surge	7 ADC @ 24 VDC for 1 msec 3 ADC @ 24 VDC for 20 msec
Maximum Power Dissipation	6 W for each protection module, 5 W for Modbus module 22W, 33W with Transient. (Please see individual spec sheets for additional protection modules power specifications.)

*Note: Temperature ratings are for rack electronics only. Cooling is required if enclosure (ambient + enclosure heat rise) temperatures exceed these limits.

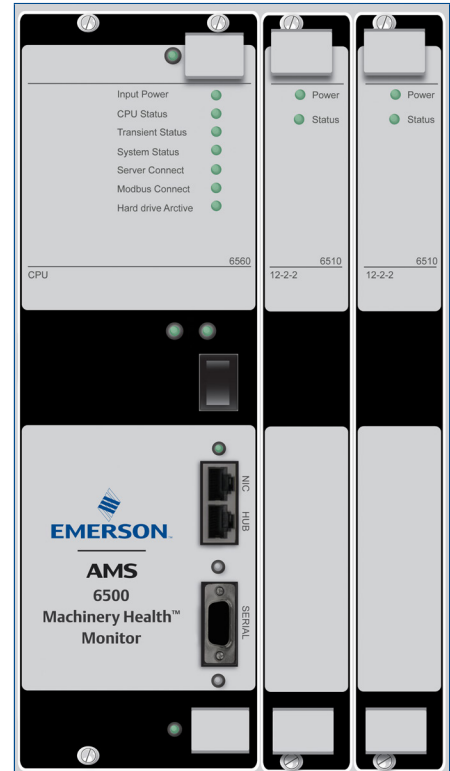

A6500TS, A6500MS for Small or Remote Prediction Only Applications

- Small width prediction only chassis only 7.5” wide
- QQ Rolling element bearing and gearbox monitoring and optional transient monitoring
- QQ Can be configured either in simple transmitter mode for Modbus communication to control system or configured for full integration to AMS Machinery Manager

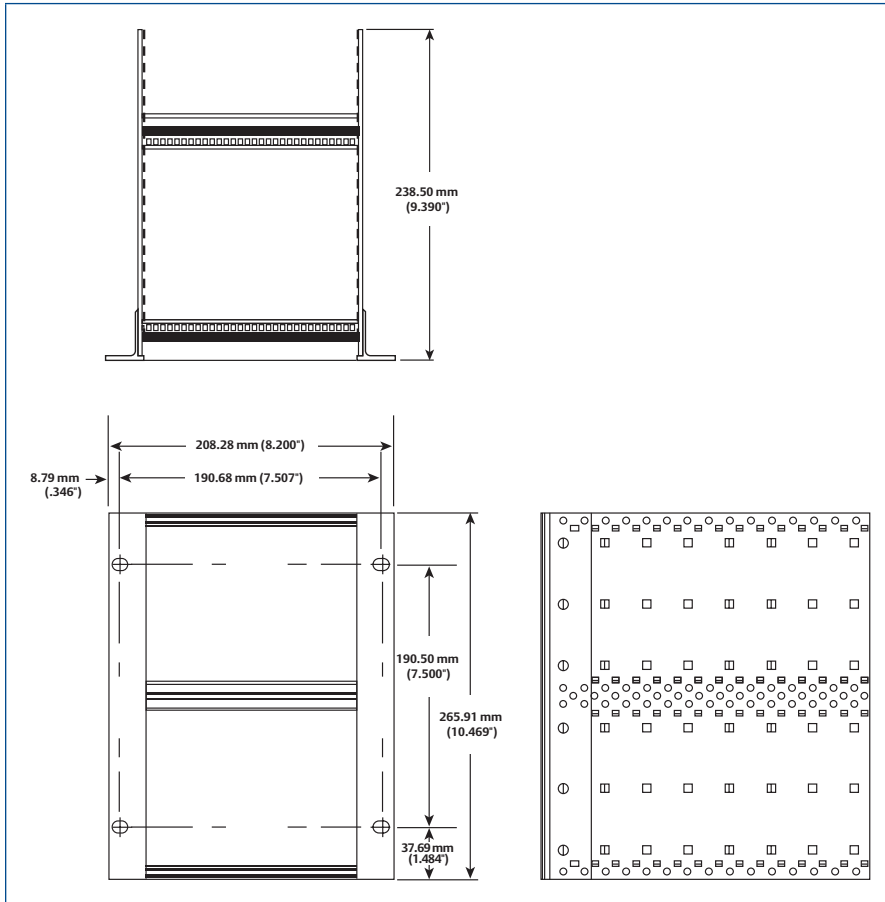

Dimensional drawing applicable for part numbers: A6500MS-12, A6500MS-24, A6500TS-12, A6500TS-24

Emerson
Reliability Solutions
 835 Innovation Drive
 Knoxville, TN 37932 USA
 ☎ +1 865 675 2400
 🌐 www.emerson.com/ams

©2018, Emerson. All rights reserved.

The Emerson logo is a trademark and service mark of Emerson Electric Co. The AMS logo is a mark of one of the Emerson family of companies. All other marks are the property of their respective owners.

The contents of this publication are presented for informational purposes only, and while diligent efforts were made to ensure their accuracy, they are not to be construed as warranties or guarantees, express or implied, regarding the products or services described herein or their use or applicability. All sales are governed by our terms and conditions, which are available on request. We reserve the right to modify or improve the designs or specifications of our products at any time without notice.