



# Improving Natural Gas Production, Transmission and Distribution Sustainability by Reducing Emissions

Proven expertise in engineered and integrated solutions to help create greener, more cost-effective operations



Click to begin



# What are emissions, what are the sources and why the need for mitigation?



Emissions are leaks and unwanted releases of gases and vapors into the atmosphere. They escape from poorly controlled storage tanks, pipelines, wells, valves, or other pressurized equipment typically used in the fossil fuel supply chain. Most are refrigerants and natural gas, but they can also include other greenhouse gases such as carbon dioxide, perfluorocarbons, sulfur hexafluoride and nitrogen trifluoride.

By reducing emissions, organizations can take positive steps in response to the climate change crisis, with tangible actions producing measurable results. The best way to prevent emissions is to make sure all equipment is intentionally designed to eliminate or reduce emissions.

As the cleanest fossil fuel, natural gas is taking a growing role in the global energy picture. Natural gas is 70-90% methane, which is particularly potent as a greenhouse gas.



"...fugitive emissions account for a significant share of the global greenhouse gas emissions: at least 2GTCO<sub>2</sub> i.e 5% of the total."

- "Climate Change 2018 Annual Report", Global Observatory on Non-State Climate Action, 2018



"20% of the world's annual 570 million metric tons of methane emissions are fugitive."

- "Methane Tracker 2020", IEA, March 2020



"In an ambitious scenario, Hydrogen is expected to meet 31% of final natural gas heating demand in the US by 2050."

- "Road Map To A US Hydrogen Economy", FCHEA, October 2020



# Emerson – One partner for your safety and reliability

Emerson's extensive portfolio of instrumentation, gas analysis, pressure regulation and automation system solutions is designed to address the quality and performance needs required by customers within the traditional fossil and growing renewable energy markets. With our solutions, you can expect innovative, extensively tested, precise and reliable products designed for the most demanding natural gas, LNG and hydrogen applications.

Across the entire energy value chain, Emerson's global technologies are backed by industry experts who understand customer expectations relating to reliability, safety and cost. In natural gas and LNG distribution, our product brands such as ASCO™, Fisher™, Micro Motion™ and Rosemount™ have consistently exceeded industry standards for minimizing risks and providing best-in-class performance.



# Emerson – One partner for your safety and reliability

Emerson's extensive portfolio of instrumentation, gas analysis, pressure regulation and automation system solutions is designed to address the quality and performance needs required by customers within the traditional fossil and growing renewable energy markets. With our solutions, you can expect innovative, extensively tested, precise and reliable products designed for the most demanding natural gas, LNG and hydrogen applications.

Across the entire energy value chain, Emerson's global technologies are backed by industry experts who understand customer expectations relating to reliability, safety and cost. In natural gas and LNG distribution, our product brands such as ASCO™, Fisher™, Micro Motion™ and Rosemount™ have consistently exceeded industry standards for minimizing risks and providing best-in-class performance.



Leading pressure control, measurement, electrical and automation systems technologies



- Explore the industry's most complete portfolio of high-performing components suited for natural gas, LNG and hydrogen/natural gas blend applications.
- Partner with Emerson to identify products or integrated solutions to suit specific natural gas, liquification and hydrogen blending applications.
- One-stop shopping eliminates supplier inefficiencies.

# Emerson – One partner for your safety and reliability

Emerson's extensive portfolio of instrumentation, gas analysis, pressure regulation and automation system solutions is designed to address the quality and performance needs required by customers within the traditional fossil and growing renewable energy markets. With our solutions, you can expect innovative, extensively tested, precise and reliable products designed for the most demanding natural gas, LNG and hydrogen applications.

Across the entire energy value chain, Emerson's global technologies are backed by industry experts who understand customer expectations relating to reliability, safety and cost. In natural gas and LNG distribution, our product brands such as ASCO™, Fisher™, Micro Motion™ and Rosemount™ have consistently exceeded industry standards for minimizing risks and providing best-in-class performance.



Application experts around the globe



- Work with experts backed by over 100 years of experience in measurement, pressure control and electrical equipment in hazardous areas.
- Consult with engineers, metallurgists and R&D personnel to select the right solution for your application.
- Apply innovative technologies to provide real-time insight, operational certainty and assured safety.
- Globally recognized R&D facilities, testing centers and manufacturing facilities that design and deliver exceptional solutions.

# Emerson – One partner for your safety and reliability

Emerson's extensive portfolio of instrumentation, gas analysis, pressure regulation and automation system solutions is designed to address the quality and performance needs required by customers within the traditional fossil and growing renewable energy markets. With our solutions, you can expect innovative, extensively tested, precise and reliable products designed for the most demanding natural gas, LNG and hydrogen applications.

Across the entire energy value chain, Emerson's global technologies are backed by industry experts who understand customer expectations relating to reliability, safety and cost. In natural gas and LNG distribution, our product brands such as ASCO™, Fisher™, Micro Motion™ and Rosemount™ have consistently exceeded industry standards for minimizing risks and providing best-in-class performance.



Engineered Solutions  
and Services



- Application consultation available to help optimize product performance and optimization.
- Network of support specialists available for product lifecycle management.
- Upskill your personnel through tailored training options and lifecycle services.



# Products to reduce emissions across the natural gas value chain

Natural gas production sites can release significant amounts of methane to the atmosphere and there are countless other opportunities for leaks through the processing and distribution chain from well-head to final consumer. Making that trip, a given volume of natural gas will pass through hundreds of valves, regulators, compressors and storage tanks. These may bleed off tiny amounts individually, but the cumulative effect, over time, makes an unceasing contribution to the climate change picture. Reversing this calls for a comprehensive effort, but often implemented one device at a time.

## PRODUCTION

Wellpad operators have been a target of environmentalists due to the volume of emissions and heavy flaring performed at these sites. Actual measurements of emissions show they are higher than projected by the U.S. EPA.

Producers concerned about sustainability are undertaking major equipment upgrades to reduce emissions and reduce product loss. Improvements to valves supporting the “Christmas tree,” gathering lines and gas processing units can reduce or eliminate leaks and losses.

## TRANSPORTATION

Once captured and moved into the transmission system, opportunities for leakage tend to be smaller, but there are many more of them. A poorly maintained compressor or storage facility can bleed natural gas into the atmosphere.

Long transmission lines and taps that receive inadequate maintenance emit their share.

## DISTRIBUTION

As distribution gets closer to individual customers, pipes are smaller and there are many more of them, each with multiple valves and connection points. Users can be anything from an individual residence to a power plant.

Custody transfers to local utilities are required, creating other opportunities for leaks and losses. With many individual regulators, meters and pipes, even microscopic leaks can multiply, resulting in significant emissions.





# PRODUCTION

## What's your challenge?

With Emerson, you can strengthen your **environmental stewardship** by **minimizing emissions**, improving **energy efficiency**, enhancing safety performance, and optimizing reliability while simultaneously benefiting from more profitable production.

- Wellhead
- Gathering Lines
- Gas Production Unit

"...fugitive emissions account for a significant share of the global greenhouse gas emissions: at least 2GTCO<sub>2</sub> i.e 5% of the total."

- "Climate Change 2018 Annual Report", Global Observatory on Non-State Climate Action, 2018

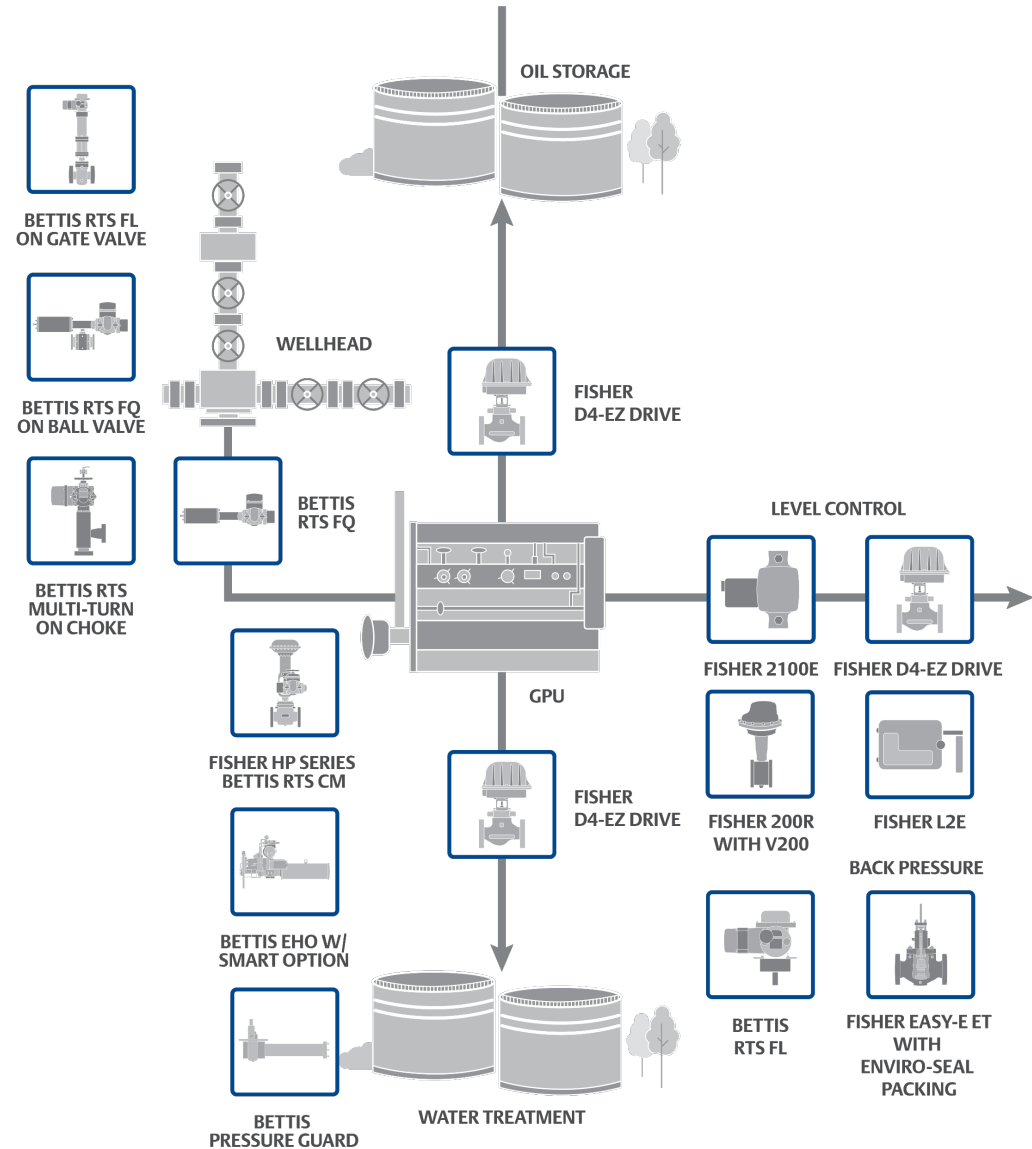



# PRODUCTION - WELLHEAD

-  Wellhead
-  Gathering Lines
-  Gas Production Unit

The wellhead is the first interface of downhole fluids to the surface and provides an interface for the fluid from the ground to the topside facility. Pneumatic devices and operational issues provide **opportunities to reduce methane emissions** at the wellhead.

## Solutions

-  Bettis RTS FQ
-  Bettis RTS CM
-  Bettis RTS FL

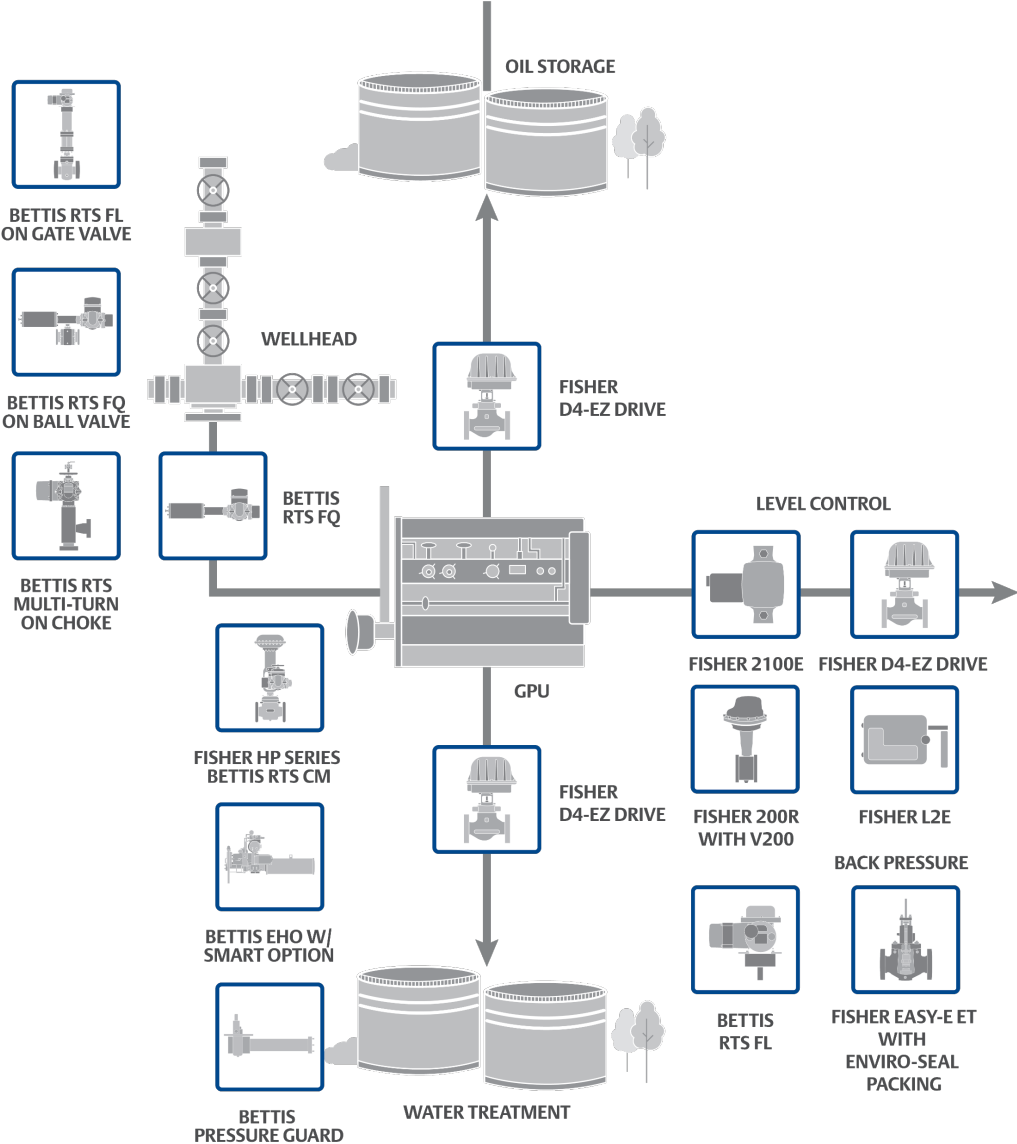

# PRODUCTION - WELLHEAD

- Wellhead
- Gathering Lines
- Gas Production Unit

The wellhead is the first interface of downhole fluids to the surface and provides an interface for the fluid from the ground to the topside facility. Pneumatic devices and operational issues provide **opportunities to reduce methane emissions** at the wellhead.

## Solutions

- Bettis RTS FQ
- Bettis RTS CM
- Bettis RTS FL

## Bettis™ RTS FQ



A non-intrusive intelligent fail-safe quarter-turn actuator for ON/OFF and modulation control in fail-safe applications. The robust and compact mechanical spring return design can be triggered to fail-safe action either on loss of power or signal. With no dependency on super-capacitor or battery-backup, this state-of-the-art design is widely used on valves for energy and applications.

*Bettis RTS FQ  
Product information*



## Emissions Reduction Opportunities

Fail-safe Quarter-Turn Electric Actuation can provide ball valve safety function on wellhead ESD while eliminating vented methane from valve operation.



# PRODUCTION - WELLHEAD

- Wellhead
- Gathering Lines
- Gas Production Unit

The wellhead is the first interface of downhole fluids to the surface and provides an interface for the fluid from the ground to the topside facility. Pneumatic devices and operational issues provide **opportunities to reduce methane emissions** at the wellhead.

## Solutions

- Bettis RTS FQ
- Bettis RTS CM
- Bettis RTS FL

## Bettis™ RTS CM



A non-intrusive intelligent compact multi-turn electric actuator for ON/OFF and Process control applications. The robust and compact design offers continuous modulation with configurable speed options that are widely used on valves in energy applications.

*Bettis RTS CM*  
*Product information*

## Emissions Reduction Opportunities

High-speed modulating performance will optimize well control and reduce flaring and ESD events.

# PRODUCTION - WELLHEAD

- Wellhead
- Gathering Lines
- Gas Production Unit

The wellhead is the first interface of downhole fluids to the surface and provides an interface for the fluid from the ground to the topside facility. Pneumatic devices and operational issues provide **opportunities to reduce methane emissions** at the wellhead.

## Solutions

- Bettis RTS FQ
- Bettis RTS CM
- Bettis RTS FL

## Bettis™ RTS FL



A non-intrusive intelligent fail-safe linear actuator for ON/OFF and modulation control in fail-safe applications. The robust and compact mechanical spring return design can be triggered to fail-safe action either on loss of power or signal. With no dependency on super-capacitor or battery-backup, this state-of-the-art design is widely used on valves for energy applications.

*Bettis RTS FL*  
*Product information*

## Emissions Reduction Opportunities

Fail-safe Electric Linear Actuation can provide gate valve safety function on wellhead ESD while eliminating vented methane from valve operation.

# PRODUCTION - GATHERING LINES

-  Wellhead
-  Gathering Lines
-  Gas Production Unit

Gathering system equipment reliability and field personnel efficiency are critical for maximizing your operation uptime. Surge control, overpressure protection, and compression system reliability are essential to achieving your throughput and availability goals which in turn **reduce fugitive emissions**.

## Solutions

-  Bettis RTS FQ
-  Bettis EHO with Smart Option
-  Bettis Pressure Guard

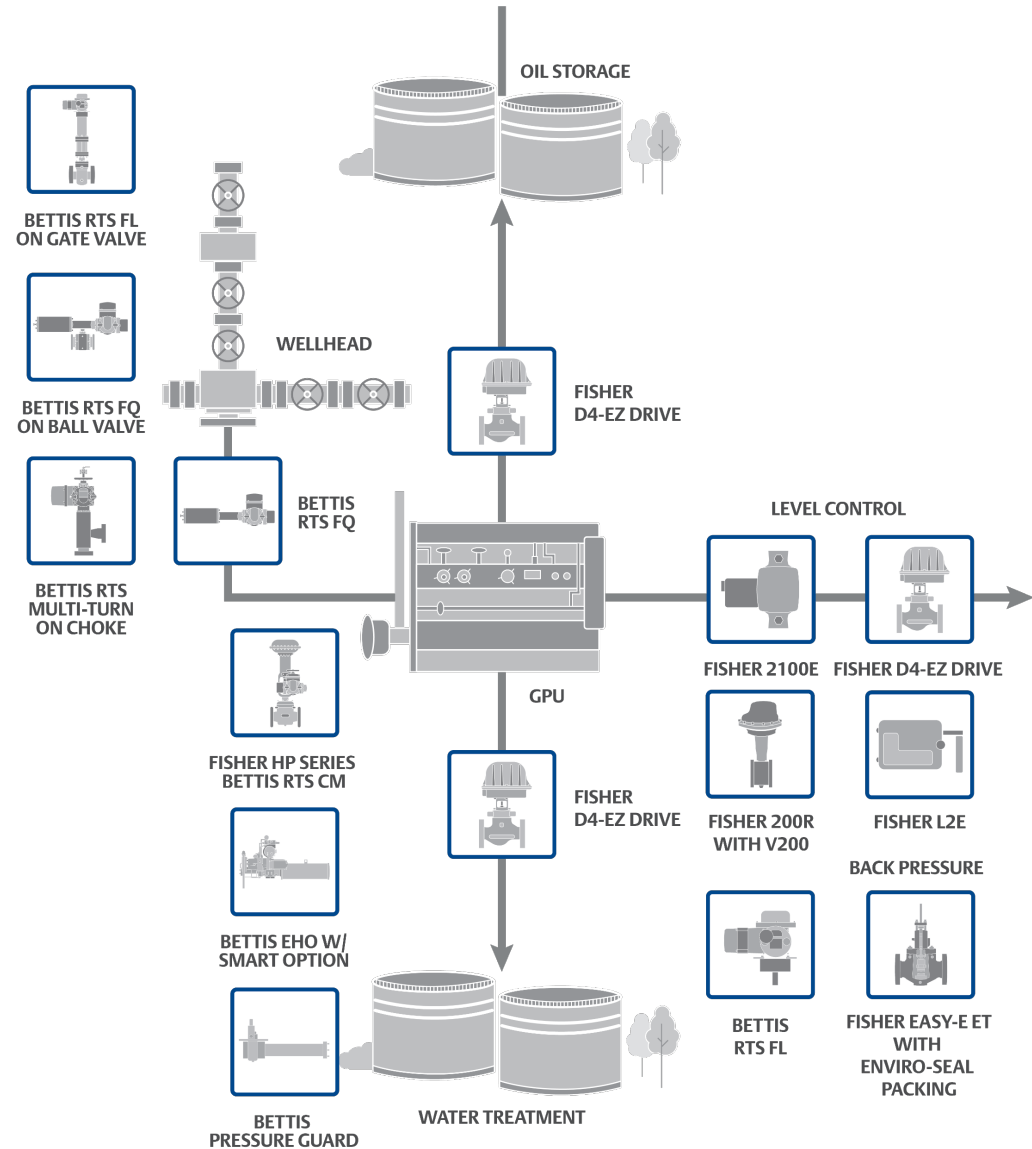

# PRODUCTION - GATHERING LINES

- Wellhead
- Gathering Lines
- Gas Production Unit

Gathering system equipment reliability and field personnel efficiency are critical for maximizing your operation uptime. Surge control, overpressure protection, and compression system reliability are essential to achieving your throughput and availability goals which in turn **reduce fugitive emissions**.

## Solutions

- Bettis RTS FQ
- Bettis EHO with Smart Option
- Bettis Pressure Guard

## Bettis™ RTS FQ



A non-intrusive intelligent fail-safe quarter-turn actuator for ON/OFF and modulation control in fail-safe applications. The robust and compact mechanical spring return design can be triggered to fail-safe action either on loss of power or signal. With no dependency on super-capacitor or battery-backup, this state-of-the-art design is widely used on valves for energy and applications.

*Bettis RTS FQ  
Product information*



## Emissions Reduction Opportunities

Fail-safe electric actuator will provide the torque and speed requirements for ESD operation on small to midsize mainline valve while eliminating vented methane from valve operation.



# PRODUCTION - GATHERING LINES

- Wellhead
- Gathering Lines
- Gas Production Unit

Gathering system equipment reliability and field personnel efficiency are critical for maximizing your operation uptime. Surge control, overpressure protection, and compression system reliability are essential to achieving your throughput and availability goals which in turn **reduce fugitive emissions**.

## Solutions

- Bettis RTS FQ
- Bettis EHO with Smart Option
- Bettis Pressure Guard

## Bettis™ EHO with Smart Option



The Bettis Smart Electro-Hydraulic Operator (EHO) is a self-contained electro-hydraulic actuator designed to actuate quarter-turn valves. It is designed to provide fail-safe actuation for Emergency Shut Down (ESD) valves. The Bettis Smart EHO has advanced diagnostic capability and can be connected to DCMLink for remote monitoring.

*Bettis EHO with Smart Option  
Product information*



## Emissions Reduction Opportunities

Smart EHO will provide the torque and speed requirements for ESD operation on larger mainline valve while eliminating vented methane from valve operation.



# PRODUCTION - GATHERING LINES

- Wellhead
- Gathering Lines
- Gas Production Unit

Gathering system equipment reliability and field personnel efficiency are critical for maximizing your operation uptime. Surge control, overpressure protection, and compression system reliability are essential to achieving your throughput and availability goals which in turn **reduce fugitive emissions**.

## Solutions

- Bettis RTS FQ
- Bettis EHO with Smart Option
- Bettis Pressure Guard

## Bettis™ Pressure Guard



This hydraulic emergency shutdown system can perform valve shutdown with or without power. It is a self-contained hydraulic ESD system designed to provide reliable valve shut down on production wellheads.

*Bettis Pressure Guard  
Product information*



## Emissions Reduction Opportunities

This self-contained solution can provide ESD safety function in the most remote sites while eliminating vented methane emissions from valve operation.











# PRODUCTION - GAS PRODUCTION UNIT

-  Wellhead
-  Gathering Lines
-  Gas Production Unit

The gas production unit is used on gas condensate wells and typically consists of a gas-fired indirect heater and a separator mounted on a skid. Within the separator, a lack of process efficiency can result in production streams being routed incorrectly, with entrained gas in the oil leg leading to increased emissions downstream at the tank battery. Using devices that ensure correct fluid control at the separator helps **minimize these fugitive emissions** and gets producers closer to their sustainability targets.

## Solutions

- |  |   |
|--|---|
| <ul style="list-style-type: none"> <li> Bettis RTS CM</li> <li> Fisher HP Series Control Valve</li> <li> Fisher 2100E</li> <li> Fisher D3/4 easy-Drive Valve</li> </ul> | <ul style="list-style-type: none"> <li> Fisher L2e</li> <li> Fisher easy-Drive 200R with V200 Control Valve</li> <li> Fisher easy-E ET Globe Valve with ENVIRO-SEAL packing</li> <li> Bettis RTS FL</li> </ul> |
|--|---|

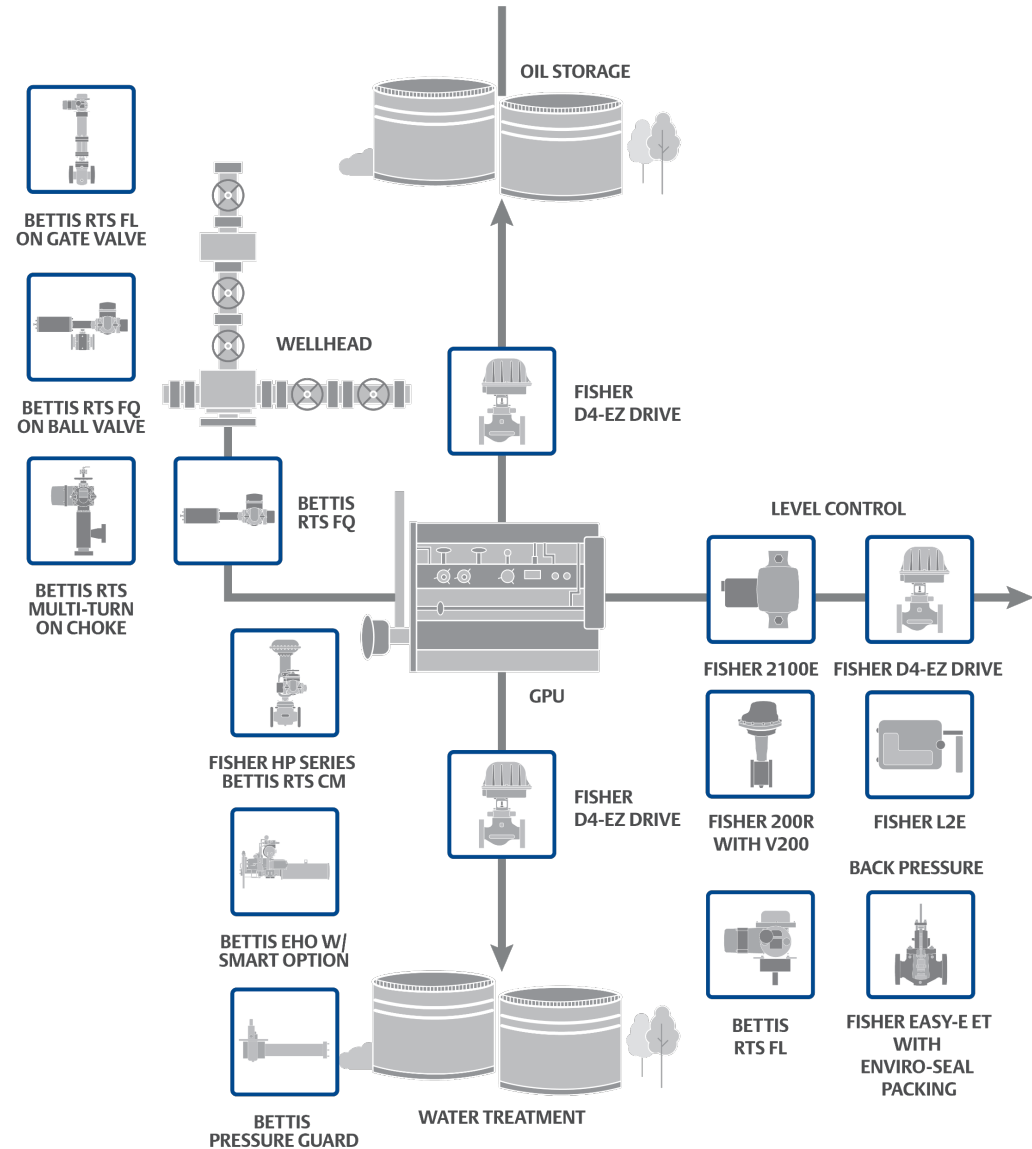

# PRODUCTION - GAS PRODUCTION UNIT

- Wellhead
- Gathering Lines
- Gas Production Unit**

The gas production unit is used on gas condensate wells and typically consists of a gas-fired indirect heater and a separator mounted on a skid. Within the separator, a lack of process efficiency can result in production streams being routed incorrectly, with entrained gas in the oil leg leading to increased emissions downstream at the tank battery. Using devices that ensure correct fluid control at the separator helps **minimize these fugitive emissions** and gets producers closer to their sustainability targets.

## Solutions

- Bettis RTS CM
- Fisher L2e
- Fisher HP Series Control Valve
- Fisher easy-Drive 200R with V200 Control Valve
- Fisher 2100E
- Fisher easy-E ET Globe Valve with ENVIRO-SEAL packing
- Fisher D3/4 easy-Drive Valve
- Bettis RTS FL

## Bettis™ RTS CM



A non-intrusive intelligent compact multi-turn electric actuator for ON/OFF and Process control applications. The robust and compact design offers continuous modulation with configurable speed options that are widely used on valves in energy applications.

*Bettis RTS CM*  
Product information



## Emissions Reduction Opportunities

High speed modulating performance will optimize well control and reduce flaring and ESD events.



## PRODUCTION - GAS PRODUCTION UNIT

- Wellhead
- Gathering Lines
- Gas Production Unit**

The gas production unit is used on gas condensate wells and typically consists of a gas-fired indirect heater and a separator mounted on a skid. Within the separator, a lack of process efficiency can result in production streams being routed incorrectly, with entrained gas in the oil leg leading to increased emissions downstream at the tank battery. Using devices that ensure correct fluid control at the separator helps **minimize these fugitive emissions** and gets producers closer to their sustainability targets.

### Solutions

- Bettis RTS CM
- Fisher HP Series Control Valve**
- Fisher 2100E
- Fisher D3/4 easy-Drive Valve
- Fisher L2e
- Fisher easy-Drive 200R with V200 Control Valve**
- Fisher easy-E ET Globe Valve with ENVIRO-SEAL packing**
- Bettis RTS FL

### Fisher™ HP Series Control Valve



Fisher HP series control valves are single-port, high-pressure, globe valves with metal seats, cage guides and push-down-to-close valve plug action. These valves are designed for high-pressure applications in Oil and Gas production applications.

*Fisher HP Series Control Valve  
Product information*



### Emissions Reduction Opportunities

When paired with Bettis™ RTS CM Electric Actuator, high speed modulating performance will optimize well control and minimize emissions from associated gas while eliminating vented methane from valve operation.



## PRODUCTION - GAS PRODUCTION UNIT

- Wellhead
- Gathering Lines
- Gas Production Unit**

The gas production unit is used on gas condensate wells and typically consists of a gas-fired indirect heater and a separator mounted on a skid. Within the separator, a lack of process efficiency can result in production streams being routed incorrectly, with entrained gas in the oil leg leading to increased emissions downstream at the tank battery. Using devices that ensure correct fluid control at the separator helps **minimize these fugitive emissions** and gets producers closer to their sustainability targets.

### Solutions

- Bettis RTS CM
- Fisher L2e
- Fisher HP Series Control Valve
- Fisher easy-Drive 200R with V200 Control Valve
- Fisher 2100E
- Fisher easy-E ET Globe Valve with ENVIRO-SEAL packing
- Fisher D3/4 easy-Drive Valve
- Bettis RTS FL

### Fisher™ 2100E



The 2100E switch uses an electric supply to sense high or low liquid levels in field processing equipment in oil and gas production applications.

*Fisher 2100E*  
Product information



### Emissions Reduction Opportunities

By utilizing an electric supply instead of natural gas, the 2100 helps minimize methane emissions and reduces concerns over Quad-O compliance.



## PRODUCTION - GAS PRODUCTION UNIT

- Wellhead
- Gathering Lines
- Gas Production Unit**

The gas production unit is used on gas condensate wells and typically consists of a gas-fired indirect heater and a separator mounted on a skid. Within the separator, a lack of process efficiency can result in production streams being routed incorrectly, with entrained gas in the oil leg leading to increased emissions downstream at the tank battery. Using devices that ensure correct fluid control at the separator helps **minimize these fugitive emissions** and gets producers closer to their sustainability targets.

### Solutions

- Bettis RTS CM
- Fisher L2e
- Fisher HP Series Control Valve
- Fisher easy-Drive 200R with V200 Control Valve
- Fisher 2100E
- Fisher easy-E ET Globe Valve with ENVIRO-SEAL packing
- Fisher D3/4 easy-Drive Valve
- Bettis RTS FL

### Fisher™ D3/4 easy-Drive Valve



The D3/4 easy-Drive valve controls backpressure outflow with low power, electrically actuated valve and flexible control signal interface.

[Fisher D3/4 easy-Drive Valve Product information](#)

### Emissions Reduction Opportunities

Use of electric actuator eliminates methane emissions associated with pneumatic actuators powered by pressurized natural gas that have been used in these applications.



# PRODUCTION - GAS PRODUCTION UNIT

- Wellhead
- Gathering Lines
- Gas Production Unit**

The gas production unit is used on gas condensate wells and typically consists of a gas-fired indirect heater and a separator mounted on a skid. Within the separator, a lack of process efficiency can result in production streams being routed incorrectly, with entrained gas in the oil leg leading to increased emissions downstream at the tank battery. Using devices that ensure correct fluid control at the separator helps **minimize these fugitive emissions** and gets producers closer to their sustainability targets.

## Fisher™ L2e



The Fisher L2e electric on/off level controller uses a displacer-type sensor to detect liquid level or the interface of two liquids of different specific gravities. This controller is ideal for controlling level in oil and gas separators, treaters and scrubbers. The reliability of the L2e force-balanced sensor design makes it well-suited for applications in the oil and natural gas production, compression and processing industries.

*Fisher L2e  
Product information*



## Solutions

- Bettis RTS CM
- Fisher L2e
- Fisher HP Series Control Valve
- Fisher easy-Drive 200R with V200 Control Valve
- Fisher 2100E
- Fisher easy-E ET Globe Valve with ENVIRO-SEAL packing
- Fisher D3/4 easy-Drive Valve
- Bettis RTS FL

## Emissions Reduction Opportunities

L2e electric level controller is a zero emission device and US Quad-O compliant.



## PRODUCTION - GAS PRODUCTION UNIT

- [Wellhead](#) [Gathering Lines](#) [Gas Production Unit](#)

The gas production unit is used on gas condensate wells and typically consists of a gas-fired indirect heater and a separator mounted on a skid. Within the separator, a lack of process efficiency can result in production streams being routed incorrectly, with entrained gas in the oil leg leading to increased emissions downstream at the tank battery. Using devices that ensure correct fluid control at the separator helps **minimize these fugitive emissions** and gets producers closer to their sustainability targets.

### Solutions

- [Bettis RTS CM](#)
- [Fisher L2e](#)
- [Fisher HP Series Control Valve](#)
- [Fisher easy-Drive 200R with V200 Control Valve](#)
- [Fisher 2100E](#)
- [Fisher easy-E ET Globe Valve with ENVIRO-SEAL packing](#)
- [Fisher D3/4 easy-Drive Valve](#)
- [Bettis RTS FL](#)

### Fisher™ easy-Drive 200R with V200 Control Valve



The Fisher easy-Drive 200R is a rugged electric actuator designed for use on rotary-shaft valve bodies in throttling or on/off applications. The actuator can be controlled via Modbus RTU, 4-20mA, or dry contact signals. Set up and calibration is performed with the Fisher easy-Drive Configurator software, which provides one button calibration. The actuator is designed to provide dependable on-off or throttling operation of control valves.

The Fisher Vee-Ball V200 control valve provides performance and cost-effectiveness across a broad range of applications. The precision-machined parts and pressure balanced seal designs allow smooth, precise valve operation. ENVIRO-SEAL™ packing systems that provide an improved stem seal to help prevent the loss of process fluid are available.

[Fisher easy-Drive 200R Product information](#)

[Fisher V200 Control Valve Product information](#)



### Emissions Reduction Opportunities

Use of the easy-Drive 200R electric actuator eliminates methane emissions associated with pneumatic actuators powered by pressurized natural gas that have been used in these applications. ENVIRO-SEAL packing is available in all Vee-Ball valves and helps meet stringent emission control requirements. The excellent stem sealing of the ENVIRO-SEAL packing system controls emissions to below the EPA minimum of 100 ppm (parts per million).





# PRODUCTION - GAS PRODUCTION UNIT

- Wellhead
- Gathering Lines
- Gas Production Unit**

The gas production unit is used on gas condensate wells and typically consists of a gas-fired indirect heater and a separator mounted on a skid. Within the separator, a lack of process efficiency can result in production streams being routed incorrectly, with entrained gas in the oil leg leading to increased emissions downstream at the tank battery. Using devices that ensure correct fluid control at the separator helps **minimize these fugitive emissions** and gets producers closer to their sustainability targets.

## Solutions

- Bettis RTS CM
- Fisher L2e
- Fisher HP Series Control Valve
- Fisher easy-Drive 200R with V200 Control Valve
- Fisher 2100E
- Fisher easy-E ET Globe Valve with ENVIRO-SEAL packing
- Fisher D3/4 easy-Drive Valve
- Bettis RTS FL

## Fisher™ easy-E ET Globe Valve with ENVIRO-SEAL packing



The Fisher easy-e ET valve is your solution for all general applications with high process temperatures, featuring a balanced plug design and cage-guided trim. ENVIRO-SEAL™ packing systems that provide an improved stem seal to help prevent the loss of process fluid are available.

*Fisher easy-E ET Globe Valve with ENVIRO-SEAL packing*  
*Product information*



## Emissions Reduction Opportunities

The excellent stem sealing of the ENVIRO-SEAL packing system controls emissions to below the EPA minimum of 100 ppm (parts per million).



## PRODUCTION - GAS PRODUCTION UNIT

- Wellhead
- Gathering Lines
- Gas Production Unit**

The gas production unit is used on gas condensate wells and typically consists of a gas-fired indirect heater and a separator mounted on a skid. Within the separator, a lack of process efficiency can result in production streams being routed incorrectly, with entrained gas in the oil leg leading to increased emissions downstream at the tank battery. Using devices that ensure correct fluid control at the separator helps **minimize these fugitive emissions** and gets producers closer to their sustainability targets.

### Solutions

- Bettis RTS CM
- Fisher L2e
- Fisher HP Series Control Valve
- Fisher easy-Drive 200R with V200 Control Valve
- Fisher 2100E
- Fisher easy-E ET Globe Valve with ENVIRO-SEAL packing
- Fisher D3/4 easy-Drive Valve
- Bettis RTS FL**

### Bettis™ RTS FL



A non-intrusive intelligent fail-safe linear actuator for ON/OFF and modulation control in fail-safe applications. The robust and compact mechanical spring return design can be triggered to fail-safe action either on loss of power or signal. With no dependency on super-capacitor or battery-backup, this state-of-the-art design is widely used on valves for energy applications.

*Bettis RTS FL*  
*Product information*



### Emissions Reduction Opportunities







Fail-safe Electric Linear Actuation can provide valve safety function on back pressure control while eliminating vented methane from valve operation.



# TRANSPORTATION

## What's your challenge?

Gas transmission companies use gas-powered valve operating systems for critical pipeline applications where dependability of the equipment is essential. As new regulations require operators to **reduce natural gas emissions**, users are challenged to find solutions that perform at the same level as gas-powered devices.





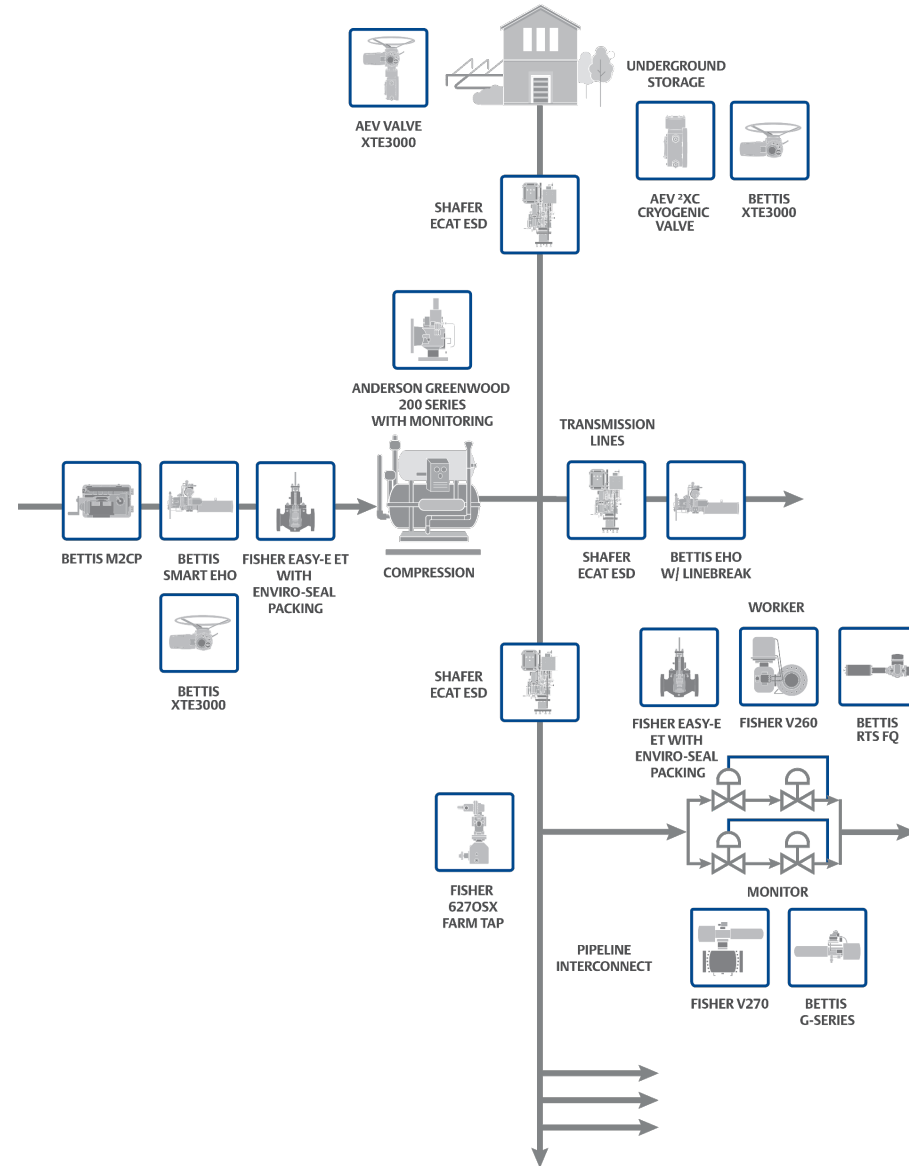
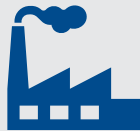

-  Gathering Lines
-  Transmission Lines
-  Gas Compression
-  Pipeline Interconnect
-  Underground Storage
-  Farmtap

“20% of the world’s annual 570 million metric tons of methane emissions are fugitive.”

- “Methane Tracker 2020”, IEA, March 2020



# TRANSPORTATION - GATHERING LINES

-  **Gathering Lines**
-  **Transmission Lines**
-  **Gas Compression**
-  **Pipeline Interconnect**
-  **Underground Storage**
-  **Farmtap**

Gathering system equipment reliability and field personnel efficiency are critical for maximizing your operation uptime. Surge control, overpressure protection, and compression system reliability are essential to achieving your throughput and availability goals which in turn **reduce fugitive emissions.**

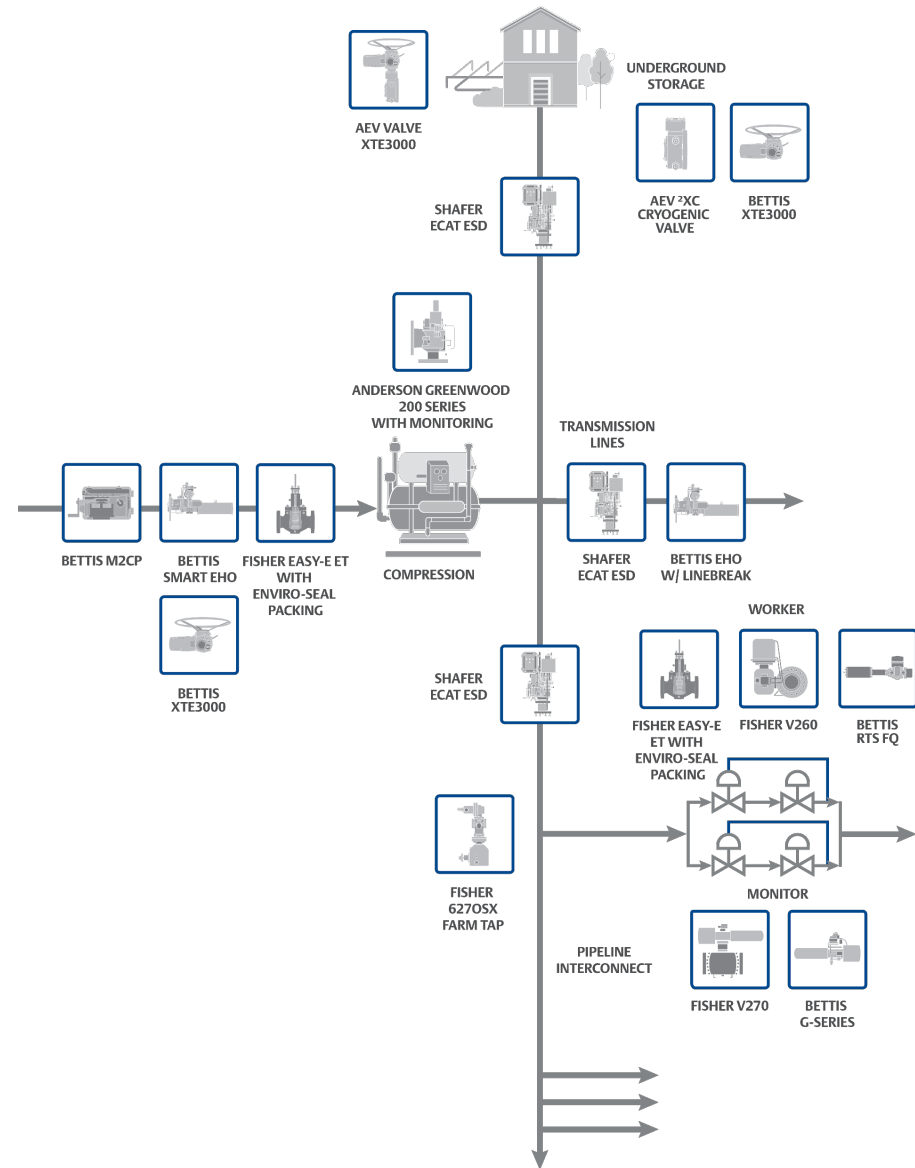







## Solutions

-  **Bettis Smart EHO**



# TRANSPORTATION - GATHERING LINES

-  Gathering Lines
-  Transmission Lines
-  Gas Compression
-  Pipeline Interconnect
-  Underground Storage
-  Farmtap

Gathering system equipment reliability and field personnel efficiency are critical for maximizing your operation uptime. Surge control, overpressure protection, and compression system reliability are essential to achieving your throughput and availability goals which in turn **reduce fugitive emissions**.

## Solutions

-  **Bettis Smart EHO**

## Bettis™ Smart EHO



The Bettis Smart Electro-Hydraulic Operator (EHO) is a self-contained electro-hydraulic actuator designed to actuate quarter-turn valves. It is designed to provide fail-safe actuation for Emergency Shut Down (ESD) valves. The Bettis Smart EHO has advanced diagnostic capability and can be connected to DCMLink for remote monitoring.







*Bettis Smart EHO  
Product information*



## Emissions Reduction Opportunities

Smart EHO will provide the torque and speed requirements for ESD operation on larger mainline valve while eliminating vented methane from valve operation.



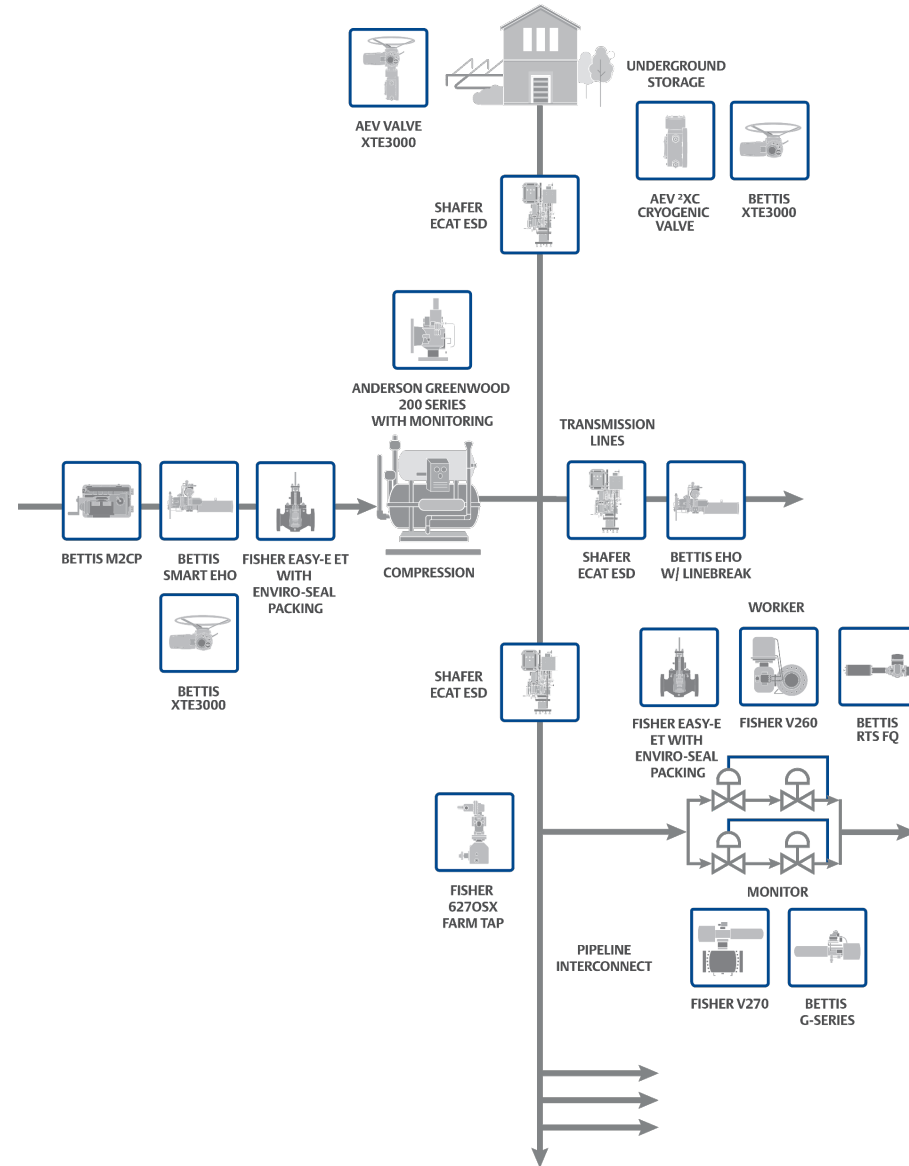

# TRANSPORTATION – GAS COMPRESSION

-  Gathering Lines
-  Transmission Lines
-  Gas Compression
-  Pipeline Interconnect
-  Underground Storage
-  Farmtap

Natural gas compressors are capable of handling expected volumes safely and without disrupting other activities. However, through exhaust, venting and **fugitive emissions** they are a leading source of methane in gas transmission operations.



## Solutions

-  Bettis M2CP
-  Fisher easy-E ET Globe Valve with ENVIRO-SEAL packing
-  Anderson Greenwood Series 200 with Monitoring
-  Bettis XTE3000



# TRANSPORTATION – GAS COMPRESSION

- ➔ Gathering Lines
- ➔ Gas Compression
- ➔ Underground Storage
- ➔ Transmission Lines
- ➔ Pipeline Interconnect
- ➔ Farmtap

Natural gas compressors are capable of handling expected volumes safely and without disrupting other activities. However, through exhaust, venting and **fugitive emissions** they are a leading source of methane in gas transmission operations.

## Solutions

- ➔ Bettis M2CP
- ➔ Fisher easy-E ET Globe Valve with ENVIRO-SEAL packing
- ➔ Anderson Greenwood Series 200 with Monitoring
- ➔ Bettis XTE3000

## Bettis™ M2CP



## Emissions Reduction Opportunities

M2CP Electric actuation in this application will eliminate venting of methane associated with valve operation.

## TRANSPORTATION – GAS COMPRESSION

- ➔ Gathering Lines
- ➔ Gas Compression
- ➔ Underground Storage
- ➔ Transmission Lines
- ➔ Pipeline Interconnect
- ➔ Farmtap

Natural gas compressors are capable of handling expected volumes safely and without disrupting other activities. However, through exhaust, venting and **fugitive emissions** they are a leading source of methane in gas transmission operations.

### Solutions

- ➔ Bettis M2CP
- ➔ Fisher easy-E ET Globe Valve with ENVIRO-SEAL packing
- ➔ Anderson Greenwood Series 200 with Monitoring
- ➔ Bettis XTE3000

### Fisher™ easy-E™ ET Globe Valve with ENVIRO-SEAL packing



The Fisher easy-e ET valve is your solution for all general applications with high process temperatures, featuring a balanced plug design and cage-guided trim. ENVIRO-SEAL™ packing systems that provide an improved stem seal to help prevent the loss of process fluid are available.

*Fisher easy-E ET Globe Valve with ENVIRO-SEAL packing  
Product information*



### Emissions Reduction Opportunities

The excellent stem sealing of the ENVIRO-SEAL packing system controls emissions to below the EPA minimum of 100 ppm (parts per million).





# TRANSPORTATION – GAS COMPRESSION

- ➔ Gathering Lines
- ➔ Gas Compression
- ➔ Underground Storage
- ➔ Transmission Lines
- ➔ Pipeline Interconnect
- ➔ Farmtap

Natural gas compressors are capable of handling expected volumes safely and without disrupting other activities. However, through exhaust, venting and **fugitive emissions** they are a leading source of methane in gas transmission operations.

## Solutions

- ➔ Bettis M2CP
- ➔ Fisher easy-E ET Globe Valve with ENVIRO-SEAL packing
- ➔ Anderson Greenwood Series 200 with Monitoring
- ➔ Bettis XTE3000

## Anderson Greenwood™ Series 200 with Monitoring



The pop-action 200 Series is still the standard of reference for pilot operated pressure relief valves. With soft seat and a non-flowing pilot, it is perfectly suited for gas service. PRV Monitoring functionality provides real-time information enabling you to proactively develop proper corrective action, optimize maintenance schedules and improve asset management while ensuring regulatory compliance.

*Anderson Greenwood Series 200 with Monitoring Product information* ➔

## Emissions Reduction Opportunities

Best in class seat tightness (fugitive emissions if venting to atmosphere). Balanced against backpressure with no need for fragile bellows that can create large fugitive emissions concerns. PRV Monitoring can tell you when a valve opened, the timestamp and duration of that event, aid in the calculation of a volumetric release and even give feedback as to whether a valve is leaking.

## TRANSPORTATION – GAS COMPRESSION

- ➔ Gathering Lines
- ➔ Gas Compression
- ➔ Underground Storage
- ➔ Transmission Lines
- ➔ Pipeline Interconnect
- ➔ Farmtap

Natural gas compressors are capable of handling expected volumes safely and without disrupting other activities. However, through exhaust, venting and **fugitive emissions** they are a leading source of methane in gas transmission operations.

### Solutions

- ➔ Bettis M2CP
- ➔ Fisher easy-E ET Globe Valve with ENVIRO-SEAL packing
- ➔ Anderson Greenwood Series 200 with Monitoring
- ➔ Bettis XTE3000

### Bettis™ XTE3000



The XTE3000 is an intelligent multi-turn electric actuator from the Bettis family of actuators. Specifically designed to meet the most challenging valve automation demands of the Oil and Gas, Power and Process industries, the XTE3000 is compliant with a wide range of international standards and is the ideal solution to your operation's safety and reliability requirements.

*Bettis XTE3000  
Product information*









### Emissions Reduction Opportunities

XTE3000 Electric actuation in this application will eliminate venting of methane associated with valve operation.





# TRANSPORTATION - UNDERGROUND STORAGE

-  Gathering Lines
-  Transmission Lines
-  Gas Compression
-  Pipeline Interconnect
-  **Underground Storage**
-  Farmtap

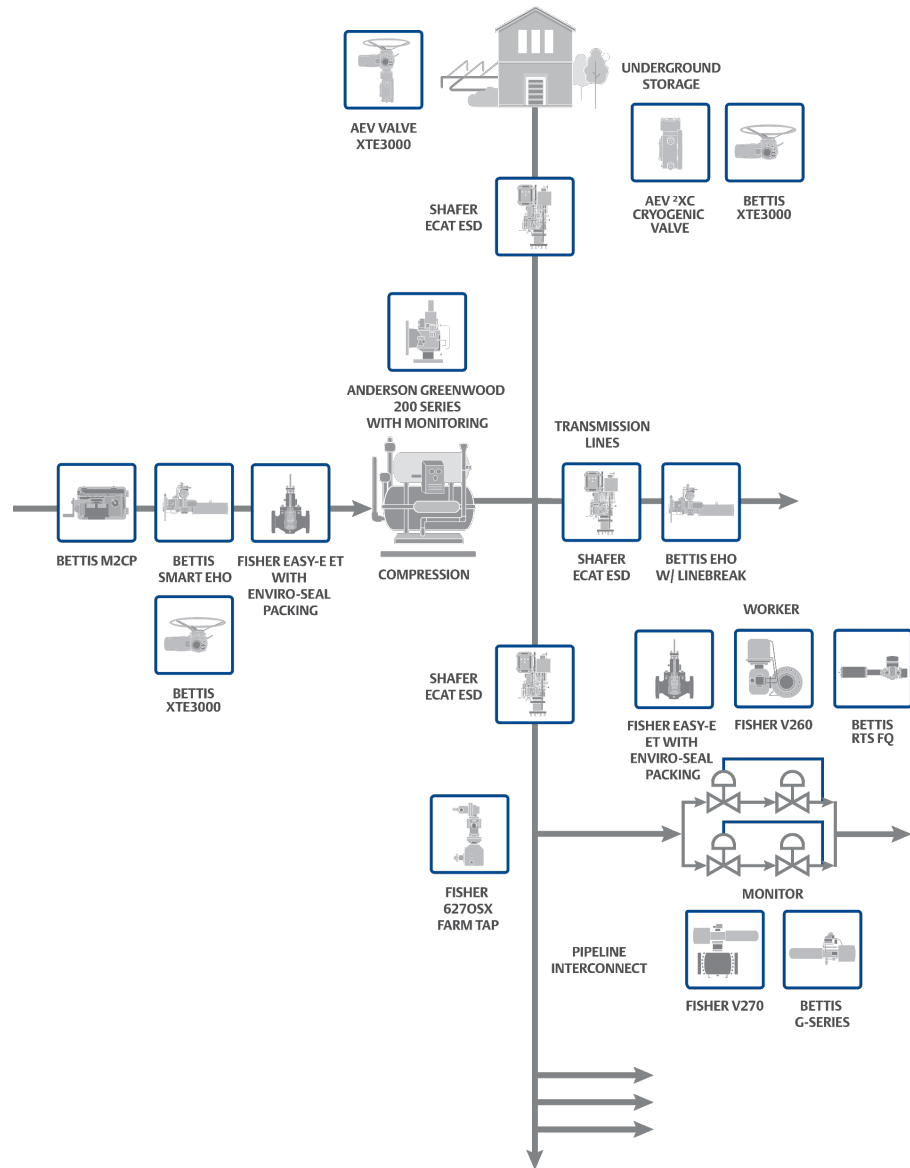
Gas that is not needed immediately is diverted into underground storage facilities. This allows excess gas delivered during the summer to be made available to help meet the increased demand in the winter. Methane emissions within storage facilities is mostly fugitive in nature, coming from **equipment leaks**.









## Solutions

-  **AEV 2XC Cryogenic C-Ball Valve**
-  **Bettis XTE3000**



# TRANSPORTATION - UNDERGROUND STORAGE

-  Gathering Lines
-  Gas Compression
-  **Underground Storage**
-  Transmission Lines
-  Pipeline Interconnect
-  Farmtap

Gas that is not needed immediately is diverted into underground storage facilities. This allows excess gas delivered during the summer to be made available to help meet the increased demand in the winter. Methane emissions within storage facilities is mostly fugitive in nature, coming from **equipment leaks**.

## AEV <sup>2</sup>XC™ Cryogenic C-Ball Valve

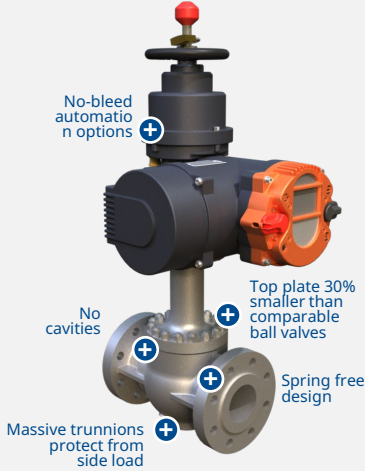

Enabled by a unique “C” ball shape and double eccentric design, the <sup>2</sup>XC ball valve acts along two vectors of movement to allow opening and closing of the valve without friction or wearing at the seat and “C” contact. At close, a zero-leakage metal to metal seal is formed by cam effect, one full order of magnitude greater than the prevailing industry standard (BS6364), assuring an ultra tight mechanical seal.

**AEV <sup>2</sup>XC Cryogenic C-Ball Valve**  
Product information 

### Solutions

-  **AEV <sup>2</sup>XC Cryogenic C-Ball Valve**
-  **Bettis XTE3000**

### Emissions Reduction Opportunities

Various packing materials can be configured with live-loading to achieve low emissions to ISO 15848.

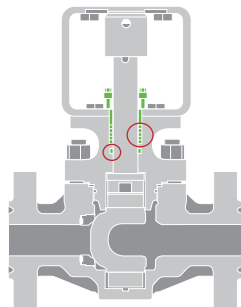

**STEM SEALING**



**LOW FE CERTIFIED**  
Futureproof your facility with ISO 15848 certification to stay ahead of fugitive emissions regulation.



**ZERO LEAKAGE**  
Mechanical torque seating against a fixed seat for bidirectional zero leakage sealing.



**REDUCE MAINTENANCE**  
Massive integral trunnions support ball absorbing any process forces to protect the stem from side load.

# TRANSPORTATION - UNDERGROUND STORAGE

- ➔ Gathering Lines
- ➔ Gas Compression
- ➔ Underground Storage
- ➔ Transmission Lines
- ➔ Pipeline Interconnect
- ➔ Farmtap

Gas that is not needed immediately is diverted into underground storage facilities. This allows excess gas delivered during the summer to be made available to help meet the increased demand in the winter. Methane emissions within storage facilities is mostly fugitive in nature, coming from **equipment leaks**.

## Solutions

- ➔ AEV <sup>2</sup>XC Cryogenic C-Ball Valve
- ➔ Bettis XTE3000

## Bettis™ XTE3000









The XTE3000 is an intelligent multi-turn electric actuator from the Bettis family of actuators. Specifically designed to meet the most challenging valve automation demands of the Oil and Gas, Power and Process industries, the XTE3000 is compliant with a wide range of international standards and is the ideal solution to your operation's safety and reliability requirements.

*Bettis XTE3000*  
*Product information* ➔

## Emissions Reduction Opportunities

XTE3000 Electric actuation in this application will eliminate venting of methane associated with valve operation.



# TRANSPORTATION - TRANSMISSION LINES

-  **Gathering Lines**
-  **Transmission Lines**
-  **Gas Compression**
-  **Pipeline Interconnect**
-  **Underground Storage**
-  **Farmtap**

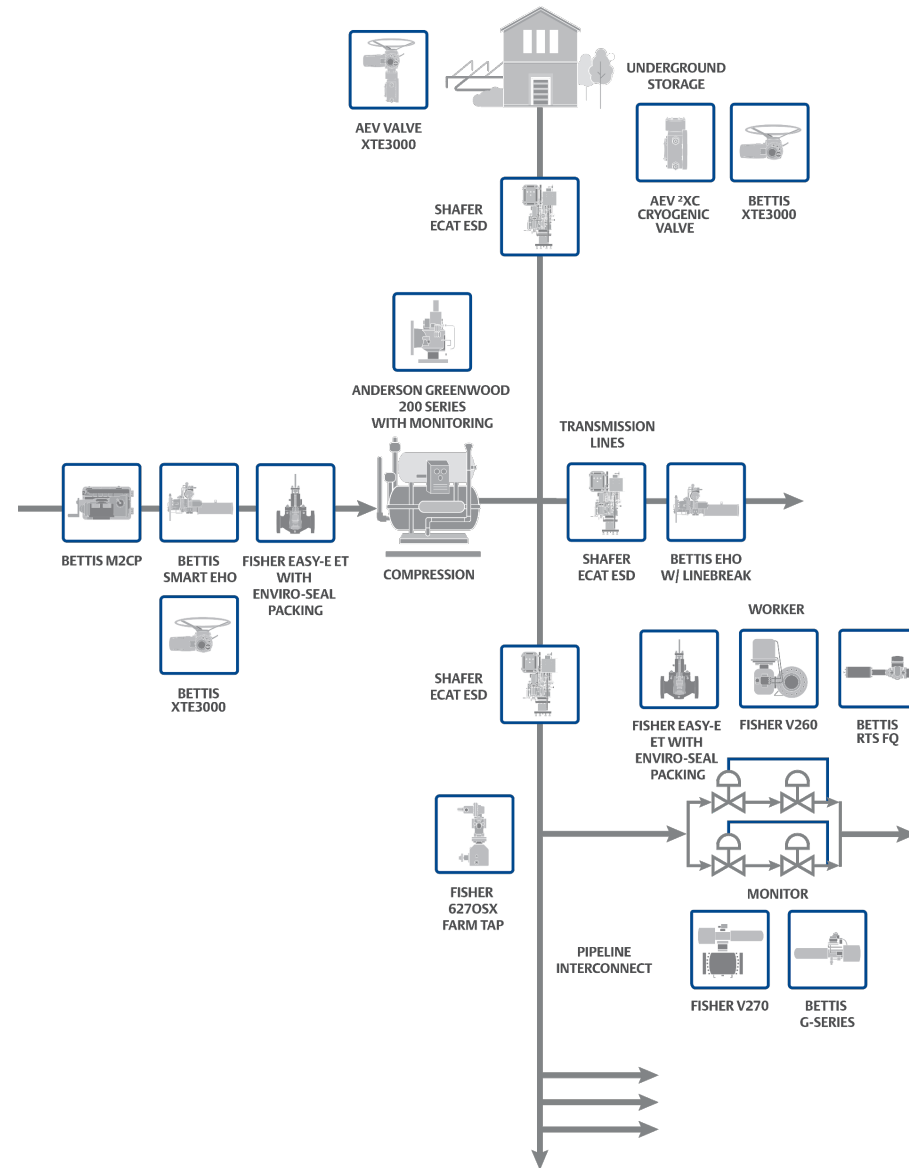
Transmission pipelines move natural gas from one place to another, usually over long distances. Control valves, pilot-operated regulators and relief valves are used to control the pressure and flow of gas through the pipelines. While operational methane releases such as venting from relief and safety devices make up a large portion of emissions within gas transmission lines there is still a significant opportunity to **reduce fugitive emissions** as well as vented emissions from ruptures.



## Solutions

-  **Shafer ECAT**
-  **Bettis EHO with Linebreak Protection**



## TRANSPORTATION - TRANSMISSION LINES

- ➔ Gathering Lines
- ➔ Gas Compression
- ➔ Underground Storage
- ➔ Transmission Lines
- ➔ Pipeline Interconnect
- ➔ Farmtap

Transmission pipelines move natural gas from one place to another, usually over long distances. Control valves, pilot-operated regulators and relief valves are used to control the pressure and flow of gas through the pipelines. While operational methane releases such as venting from relief and safety devices make up a large portion of emissions within gas transmission lines there is still a significant opportunity to **reduce fugitive emissions** as well as vented emissions from ruptures.

### Solutions

- ➔ Shafer ECAT
- ➔ Bettis EHO with Linebreak Protection

### Shafer™ ECAT



Shafer ECAT is a Valve Operating System™ for critical pipeline applications where dependability of the equipment is essential and emissions control desired. ECAT applies progressive technology to prevent emissions but also uses Emerson's proven Shafer technology and controls to stroke valves under the most demanding conditions. It is an excellent solution for environmentally sensitive applications.

[Shafer ECAT  
Product information](#)



### Emissions Reduction Opportunities

Gas-powered actuation emits gas by design. Eliminate over 99% of actuation emissions using the ECAT. Using pipeline gas to pressurize hydraulic fluid and actuate the valve, the ECAT eliminates high-pressure gas venting from the tanks through the control panel. By converting many of the typical gas connections into hydraulic, the ECAT reduces the potential for fugitive emissions.



## TRANSPORTATION - TRANSMISSION LINES

- ➔ Gathering Lines
- ➔ Gas Compression
- ➔ Underground Storage
- ➔ Transmission Lines
- ➔ Pipeline Interconnect
- ➔ Farmtap

Transmission pipelines move natural gas from one place to another, usually over long distances. Control valves, pilot-operated regulators and relief valves are used to control the pressure and flow of gas through the pipelines. While operational methane releases such as venting from relief and safety devices make up a large portion of emissions within gas transmission lines there is still a significant opportunity to **reduce fugitive emissions** as well as vented emissions from ruptures.

### Solutions

- ➔ Shafer ECAT
- ➔ Bettis EHO with Linebreak Protection

### Bettis™ EHO with Linebreak Protection



The Bettis Standard Electro-Hydraulic Operator (EHO) is a self-contained electro-hydraulic actuator designed to actuate quarter-turn valves. It is designed to provide fail-safe actuation for Emergency Shut Down(ESD) valves. The Bettis Standard EHO provides a straight-forward, simple, reliable ESD actuator solution. The LineGuard 2300 Electronic linebreak detection system monitors natural gas pipeline pressure and rate of pressure drop and can provide manual or automatic control of a single valve actuator at a station site or a remote site. This economical safety device reliably and accurately performs gas pressure calculations, actuator control, data sampling and archival and remote communications.

[Bettis EHO with Linebreak Protection Product information](#)









### Emissions Reduction Opportunities

The EHO actuator is designed as an emergency shutdown actuation solution to stop process flow upon the detection of a command signal or loss of power which helps minimize fugitive emissions associated with equipment failure.









# TRANSPORTATION - PIPELINE INTERCONNECT

-  Gathering Lines
-  Transmission Lines
-  Gas Compression
-  Pipeline Interconnect
-  Underground Storage
-  Farmtap

Pipeline Interconnects serve as the transfer point between transmission and distribution lines. Within the network **leaks and ruptures** can damage your reputation and potentially affect the health and well-being of your employees, the public and the surrounding environment.

## Solutions

-  Fisher easy-E ET Globe Valve with ENVIRO-SEAL packing
-  Bettis G-Series
-  Fisher V260 Ball Valve as Super Monitor with Bettis G Series Actuator
-  Fisher V270
-  Bettis RTS FQ

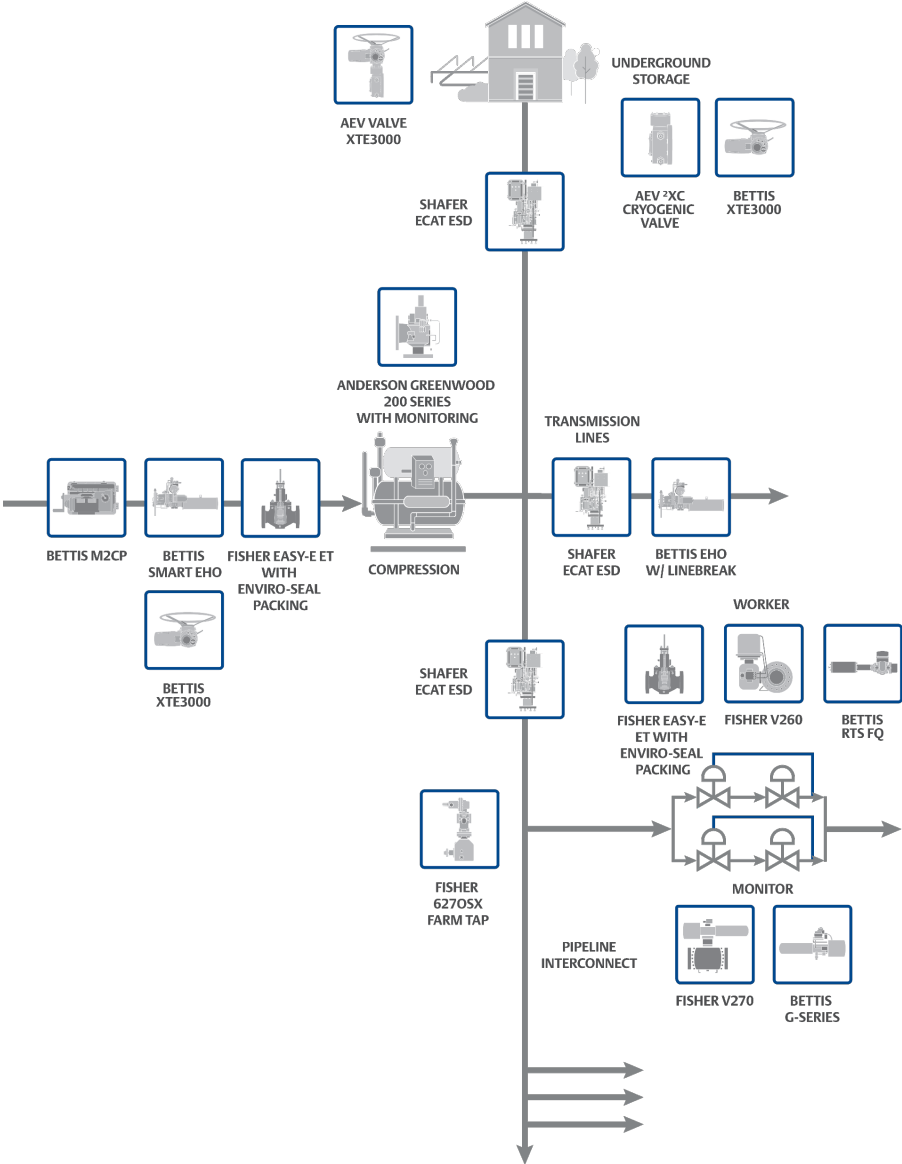

# TRANSPORTATION - PIPELINE INTERCONNECT

- ➔ Gathering Lines
- ➔ Gas Compression
- ➔ Underground Storage
- ➔ Transmission Lines
- ➔ Pipeline Interconnect
- ➔ Farmtap

Pipeline Interconnects serve as the transfer point between transmission and distribution lines. Within the network **leaks and ruptures** can damage your reputation and potentially affect the health and well-being of your employees, the public and the surrounding environment.

## Solutions

- ➔ Fisher easy-E ET Globe Valve with ENVIRO-SEAL packing
- ➔ Bettis G-Series
- ➔ Fisher V260 Ball Valve as Super Monitor with Bettis G Series Actuator
- ➔ Fisher V270
- ➔ Bettis RTS FQ

## Fisher™ easy-E™ ET Globe Valve with ENVIRO-SEAL packing



The Fisher easy-e ET valve is your solution for all general applications with high process temperatures, featuring a balanced plug design and cage-guided trim. ENVIRO-SEAL™ packing systems that provide an improved stem seal to help prevent the loss of process fluid are available.

*Fisher easy-E ET Globe Valve with ENVIRO-SEAL packing*  
*Product information*



## Emissions Reduction Opportunities

The excellent stem sealing of the ENVIRO-SEAL packing system controls emissions to below the EPA minimum of 100 ppm (parts per million).

# TRANSPORTATION - PIPELINE INTERCONNECT

- Gathering Lines
- Transmission Lines
- Gas Compression
- Pipeline Interconnect**
- Underground Storage
- Farmtap

Pipeline Interconnects serve as the transfer point between transmission and distribution lines. Within the network **leaks and ruptures** can damage your reputation and potentially affect the health and well-being of your employees, the public and the surrounding environment.

## Solutions

- Fisher easy-E ET Globe Valve with ENVIRO-SEAL packing
- Fisher V260 Ball Valve as Super Monitor with Bettis G Series Actuator**
- Bettis G-Series
- Fisher V270**
- Bettis RTS FQ

## Fisher™ V260 Ball Valve as Super Monitor with Bettis G-Series Actuator



The Fisher V260 is a full-bore control valve designed from the ground up with features for optimized pressure, flow, and process control. An integral drilled attenuator controls noise and vibration from high pressure drop liquids and gases. The splined shaft connection to the actuator reduces lost motion. ENVIRO-SEAL™ packing systems that provide an improved stem seal to help prevent the loss of process fluid are available.

[Fisher V260 Ball Valve as Super Monitor Product information](#)  
[Bettis G Series Actuator Product information](#)



## Emissions Reduction Opportunities

ENVIRO-SEAL packing system provides improved sealing, guiding, and transmission of loading force to control liquid and gas emissions.

# TRANSPORTATION - PIPELINE INTERCONNECT

- ➔ Gathering Lines
- ➔ Gas Compression
- ➔ Underground Storage
- ➔ Transmission Lines
- ➔ Pipeline Interconnect
- ➔ Farmtap

Pipeline Interconnects serve as the transfer point between transmission and distribution lines. Within the network **leaks and ruptures** can damage your reputation and potentially affect the health and well-being of your employees, the public and the surrounding environment.

## Solutions

- ➔ Fisher easy-E ET Globe Valve with ENVIRO-SEAL packing
- ➔ Fisher V260 Ball Valve as Super Monitor with Bettis G Series Actuator
- ➔ Bettis RTS FQ
- ➔ Bettis G-Series
- ➔ Fisher V270

## Bettis™ RTS FQ



A non-intrusive intelligent fail-safe quarter-turn actuator for ON/OFF and modulation control in fail-safe applications. The robust and compact mechanical spring return design can be triggered to fail-safe action either on loss of power or signal. With no dependency on super-capacitor or battery-backup, this state-of-the-art design is widely used on valves for energy and applications.

*Bettis RTS FQ*  
*Product information* ➔

## Emissions Reduction Opportunities

Fail-safe Quarter Turn Electric Actuation can provide ball valve safety function while eliminating vented methane from valve operation.

# TRANSPORTATION - PIPELINE INTERCONNECT

- ➔ Gathering Lines
- ➔ Gas Compression
- ➔ Underground Storage
- ➔ Transmission Lines
- ➔ Pipeline Interconnect
- ➔ Farmtap

Pipeline Interconnects serve as the transfer point between transmission and distribution lines. Within the network **leaks and ruptures** can damage your reputation and potentially affect the health and well-being of your employees, the public and the surrounding environment.

## Solutions

- ➔ Fisher easy-E ET Globe Valve with ENVIRO-SEAL packing
- ➔ Fisher V260 Ball Valve as Super Monitor with Bettis G Series Actuator
- ➔ Bettis RTS FQ
- ➔ Bettis G-Series
- ➔ Fisher V270

## Bettis™ G-Series



The Bettis G-Series pneumatic, scotch yoke, valve actuator is a highly unique and reliable actuator for operating ball, butterfly or plug valves along with louvers, dampers and other 90 degree rotating mechanisms. Suitable for use in demanding SIL-required applications.

*Bettis G-Series*  
*Product information* ➔

## Emissions Reduction Opportunities

The G-Series Scotch Yoke actuator can be fit with zero/low bleed controller or powered by instrument air to provide zero/low emissions operation during loss of power event to worker control valve.

# TRANSPORTATION - PIPELINE INTERCONNECT

- ➔ Gathering Lines
- ➔ Gas Compression
- ➔ Underground Storage
- ➔ Transmission Lines
- ➔ Pipeline Interconnect
- ➔ Farmtap

Pipeline Interconnects serve as the transfer point between transmission and distribution lines. Within the network **leaks and ruptures** can damage your reputation and potentially affect the health and well-being of your employees, the public and the surrounding environment.

## Solutions

- ➔ Fisher easy-E ET Globe Valve with ENVIRO-SEAL packing
- ➔ Fisher V260 Ball Valve as Super Monitor with Bettis G Series Actuator
- ➔ Bettis RTS FQ
- ➔ Bettis G-Series
- ➔ Fisher V270

## Fisher™ V270









The Fisher V270 is a three-piece, trunnion mounted, full-bore control valve designed from the ground up with features for optimized pressure, flow and process control. The V270 full-bore ball valve is designed for automated control in bypass, batch, monitor and emergency shutoff service applications, and it presents little or no restriction to flow. The V270 full-bore ball valve is available with composition seals, and process type live-loaded shaft packing for improved service life and lower emissions.

[Fisher V270 Product information](#) ➔

## Emissions Reduction Opportunities

Live-loaded shaft packing system provides improved sealing, guiding, and transmission of loading force to control liquid and gas emissions.

# TRANSPORTATION - FARMTAP

-  **Gathering Lines**
-  **Transmission Lines**
-  **Gas Compression**
-  **Pipeline Interconnect**
-  **Underground Storage**
-  **Farmtap**

Farm taps are points along a transmission pipeline where a distribution tap serves a farm or small community. They consist of high to medium and low flow applications where natural gas is being reduced to some usable pressure for use by these rural households or farms. A common issue at these sites is damage to the devices and lines, and without proper overpressure detection this damage can lead to **emissions being released into the atmosphere.**

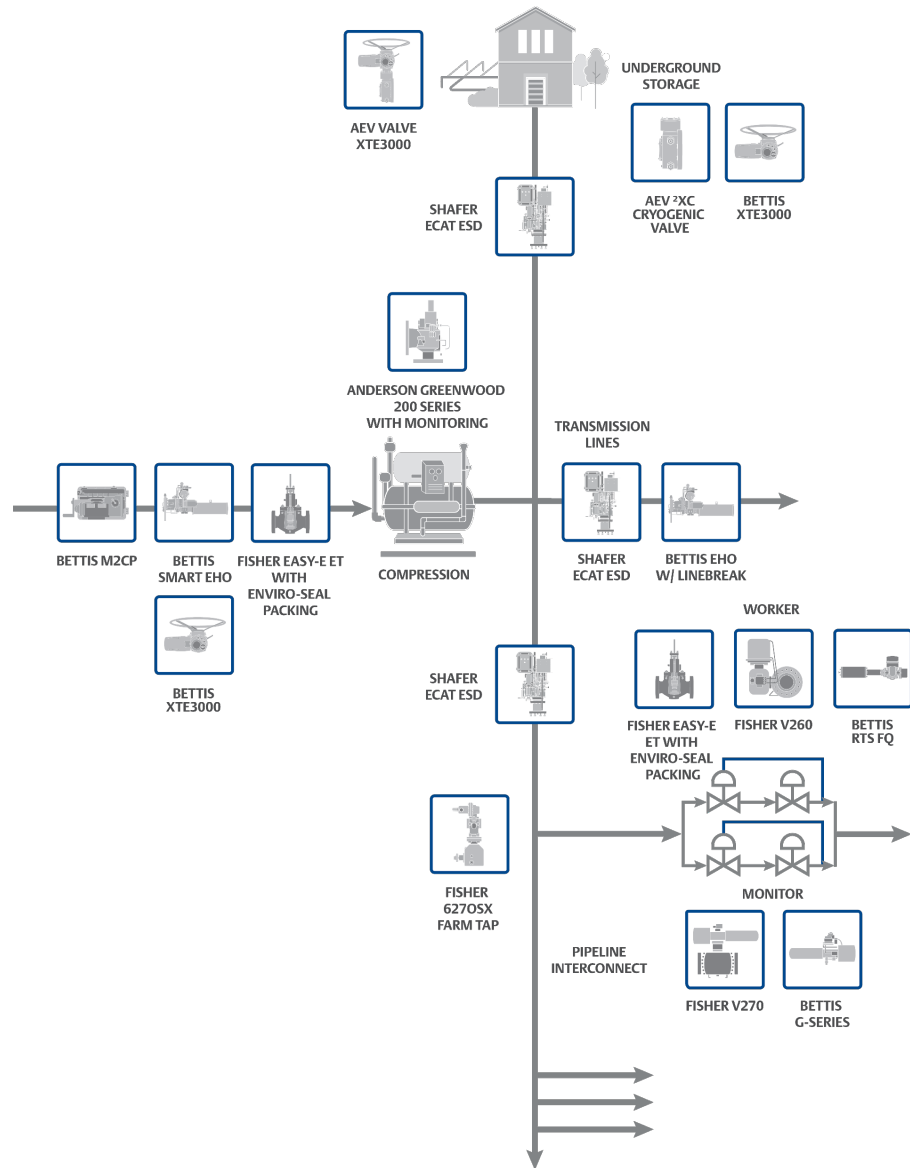

## Solutions

-  **Fisher 627-OSX**



# TRANSPORTATION - FARMTAP

- ➔ Gathering Lines
- ➔ Gas Compression
- ➔ Underground Storage
- ➔ Transmission Lines
- ➔ Pipeline Interconnect
- ➔ **Farmtap**

Farm taps are points along a transmission pipeline where a distribution tap serves a farm or small community. They consist of high to medium and low flow applications where natural gas is being reduced to some usable pressure for use by these rural households or farms. A common issue at these sites is damage to the devices and lines, and without proper overpressure detection this damage can lead to **emissions being released into the atmosphere.**

## Solutions

- ➔ **Fisher 627-OSX**

## Fisher™ 627-OSX



Fisher 627 Series direct-operated pressure reducing regulators are used in low and high-pressure systems and are very commonly found in farm tap, local distribution, and other natural gas applications. The 627-OSX has an integral slam-shut which is used to totally and rapidly cut the gas flow when the pipeline pressure reaches the slam shut's over-pressure or under-pressure trip point.

*Fisher 627-OSX  
Product information*



## Emissions Reduction Opportunities

Use of the slam-shut valve in the 627-OSX enables zero emission operation through bubble-tight pressure containment rather than direct venting to atmosphere.









# DISTRIBUTION

## What's your challenge?

In the natural gas industry, the distribution sector usually starts from city gates or gate stations where the natural gas is transferred from pipeline and compressor stations to the municipalities and local distribution companies. **Most emissions in this segment are fugitive emissions.**

- 
**City Gate / Custody Transfer**
- 
**Meter Applications**
- 
**District Regulator Station**
- 
**Power Plant Feed**
- 
**LNG**

“In an ambitious scenario, Hydrogen is expected to meet 31% of final natural gas heating demand in the US by 2050.”

- “Road Map To A US Hydrogen Economy”, FCHEA, October 2020

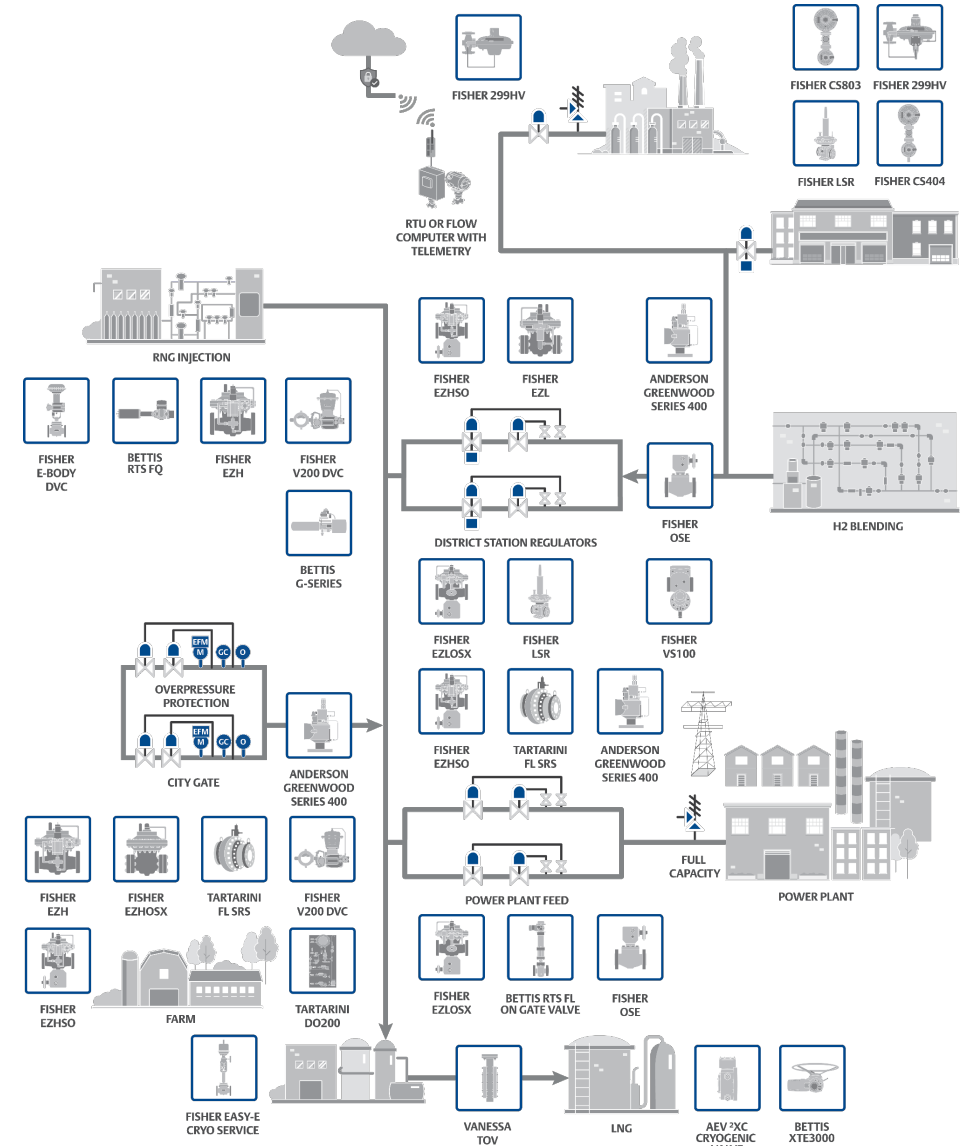





# DISTRIBUTION – CITY GATE / CUSTODY TRANSFER

-  **City Gate / Custody Transfer**
-  **Meter Applications**
-  **LNG**
-  **District Regulator Station**
-  **Power Plant Feed**

City gate stations are primary handoff locations, found between Natural Gas Transmission and Distribution companies. The stations are designed to reduce the pressure differences between the two systems, provide to provide accurate measurement, and record the transaction. It also introduces odorant, so **gas leaks can be detected** throughout the system. **Methane emissions** at gate station usually come from venting during normal valve operation and leaks in equipment components.

## Solutions

-  **Tartarini Type DO200**
-  **Fisher V200 Ball Valve with Low Bleed DVC**
-  **Fisher easy-E ET Globe Valve with ENVIRO-SEAL packing and Low Bleed DVC**
-  **Anderson Greenwood Series 400 with Monitoring**
-  **Bettis RTS FQ**
-  **Bettis G-Series Actuator**
-  **Fisher EZH**
-  **RNG Injection and H2 Blending**
-  **Fisher EZHOSX**
-  **Tartarini FL with SRS**
-  **Fisher EZHSO**

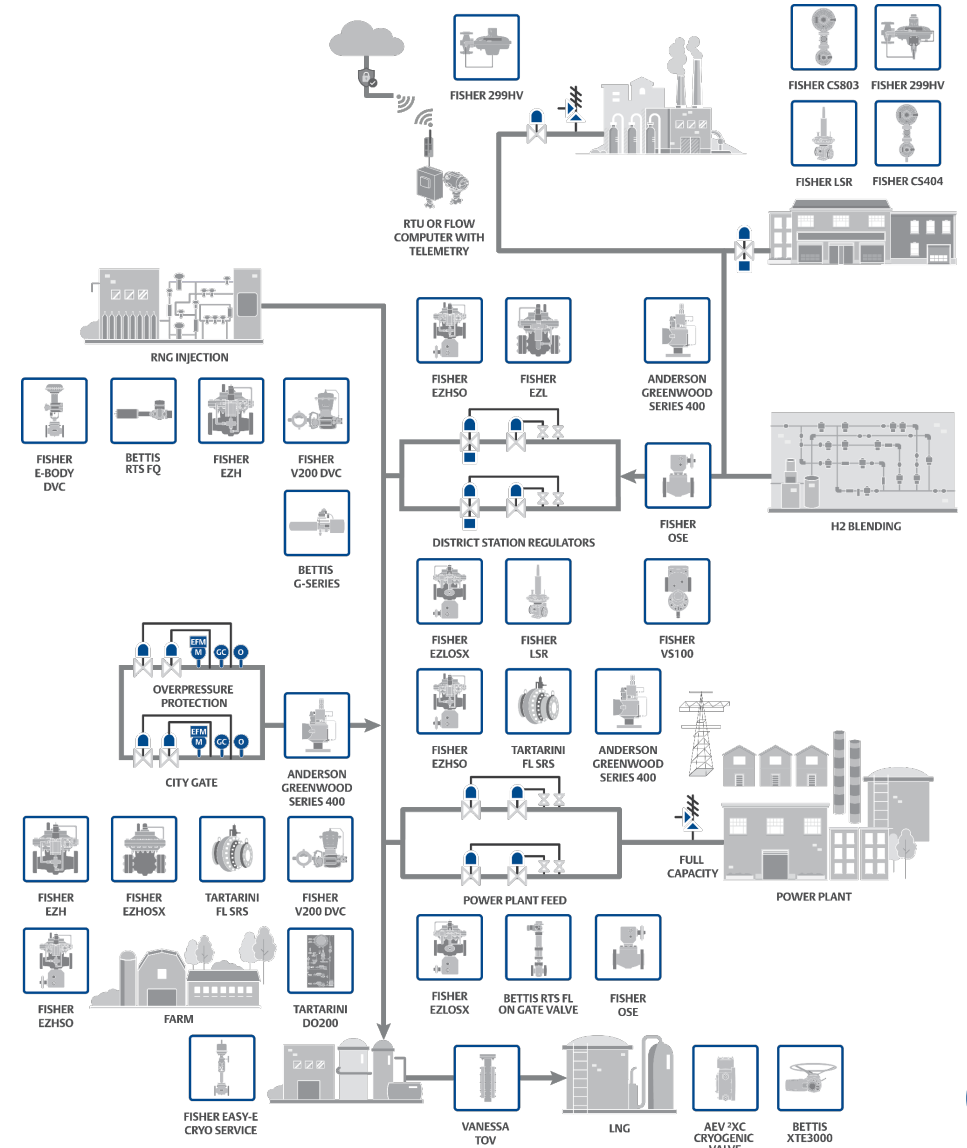

# DISTRIBUTION – CITY GATE / CUSTODY TRANSFER

- City Gate / Custody Transfer
- Meter Applications
- LNG
- District Regulator Station
- Power Plant Feed

City gate stations are primary handoff locations, found between Natural Gas Transmission and Distribution companies. The stations are designed to reduce the pressure differences between the two systems, provide to provide accurate measurement, and record the transaction. It also introduces odorant, so **gas leaks can be detected** throughout the system. **Methane emissions** at gate station usually come from venting during normal valve operation and leaks in equipment components.

## Solutions

- Tartarini Type DO200
- Fisher V200 Ball Valve with Low Bleed DVC
- Fisher easy-E ET Globe Valve with ENVIRO-SEAL packing and Low Bleed DVC
- Anderson Greenwood Series 400 with Monitoring
- Bettis RTS FQ
- Bettis G-Series Actuator
- Fisher EZH
- RNG Injection and H2 Blending
- Fisher EZHOSX
- Tartarini FL with SRS
- Fisher EZHSO

## Tartarini™ Type DO200



The DO200 is a smart odorant system for natural gas, capable of accurately injecting odorant by monitoring the flow rate of the gas in transit.

The DO200 uses redundant injectors and an emergency absorption system to eliminate downtime. The system is capable for odorizing flows with a high turndown ratio and can interface with remote monitor and control system.

*Tartarini Type DO200 Product information*

## Emissions Reduction Opportunities

The solenoid-based design of the DO200 enables zero bleed gas emitted to atmosphere.

# DISTRIBUTION – CITY GATE / CUSTODY TRANSFER

- City Gate / Custody Transfer
- Meter Applications
- LNG
- District Regulator Station
- Power Plant Feed

City gate stations are primary handoff locations, found between Natural Gas Transmission and Distribution companies. The stations are designed to reduce the pressure differences between the two systems, provide to provide accurate measurement, and record the transaction. It also introduces odorant, so **gas leaks can be detected** throughout the system. **Methane emissions** at gate station usually come from venting during normal valve operation and leaks in equipment components.

## Solutions

- Tartarini Type DO200
- Fisher V200 Ball Valve with Low Bleed DVC
- Anderson Greenwood Series 400 with Monitoring
- Bettis RTS FQ
- Bettis G-Series Actuator
- Fisher EZH
- RNG Injection and H2 Blending
- Fisher EZHOSX
- Tartarini FL with SRS
- Fisher EZHSO

## Fisher™ easy-E™ ET Globe Valve with ENVIRO-SEAL packing and Low Bleed DVC



The Fisher easy-e ET valve is your solution for all general applications with high process temperatures, featuring a balanced plug design and cage-guided trim. ENVIRO-SEAL™ packing systems that provide an improved stem seal to help prevent the loss of process fluid are available.

## Emissions Reduction Opportunities

The DVC6200 Series digital valve controllers equipped with a low bleed relay will meet the Quad-O steady-state consumption requirement of 6 scfh when used with up to a maximum 3.7 bar / 53psi natural gas supply at 16°C. The excellent stem sealing of the ENVIRO-SEAL packing system controls emissions to below the EPA minimum of 100 ppm (parts per million).

# DISTRIBUTION – CITY GATE / CUSTODY TRANSFER

- City Gate / Custody Transfer
- Meter Applications
- LNG
- District Regulator Station
- Power Plant Feed

City gate stations are primary handoff locations, found between Natural Gas Transmission and Distribution companies. The stations are designed to reduce the pressure differences between the two systems, provide to provide accurate measurement, and record the transaction. It also introduces odorant, so **gas leaks can be detected** throughout the system. **Methane emissions** at gate station usually come from venting during normal valve operation and leaks in equipment components.

## Solutions

- Tartarini Type DO200
- Fisher V200 Ball Valve with Low Bleed DVC
- Fisher easy-E ET Globe Valve with ENVIRO-SEAL packing and Low Bleed DVC
- Anderson Greenwood Series 400 with Monitoring
- Bettis RTS FQ
- Bettis G-Series Actuator
- Fisher EZH
- RNG Injection and H2 Blending
- Fisher EZHOSX
- Tartarini FL with SRS
- Fisher EZHSO

## Bettis™ RTS FQ



A non-intrusive intelligent fail-safe quarter-turn actuator for ON/OFF and modulation control in fail-safe applications. The robust and compact mechanical spring return design can be triggered to fail-safe action either on loss of power or signal. With no dependency on super-capacitor or battery-backup, this state-of-the-art design is widely used on valves for energy and applications.

*Bettis RTS FQ*  
*Product information*

## Emissions Reduction Opportunities

Fail-safe Electric actuation in this application will provide modulating performance while eliminating the methane bleed from pneumatic controllers and venting from pneumatic operation. Can be configured to fail open in concert with the Monitor Control Valve during loss of power.

# DISTRIBUTION – CITY GATE / CUSTODY TRANSFER

- City Gate / Custody Transfer
- Meter Applications
- LNG
- District Regulator Station
- Power Plant Feed

City gate stations are primary handoff locations, found between Natural Gas Transmission and Distribution companies. The stations are designed to reduce the pressure differences between the two systems, provide to provide accurate measurement, and record the transaction. It also introduces an odorant, so **gas leaks can be detected** throughout the system. **Methane emissions** at gate station usually come from venting during normal valve operation and leaks in equipment components.

## Solutions

- Tartarini Type DO200
- Fisher V200 Ball Valve with Low Bleed DVC
- Anderson Greenwood Series 400 with Monitoring
- Bettis RTS FQ
- Bettis G-Series Actuator
- Fisher EZH
- RNG Injection and H2 Blending
- Fisher EZHOSX
- Tartarini FL with SRS
- Fisher EZHSO

## Fisher™ EZH



## Emissions Reduction Opportunities

EZH Series regulators eliminate bleed gas to atmosphere by utilizing a self-contained control system, which bleeds 100% of the gas to the downstream system.

# DISTRIBUTION – CITY GATE / CUSTODY TRANSFER

- City Gate / Custody Transfer
- Meter Applications
- LNG
- District Regulator Station
- Power Plant Feed

City gate stations are primary handoff locations, found between Natural Gas Transmission and Distribution companies. The stations are designed to reduce the pressure differences between the two systems, provide to provide accurate measurement, and record the transaction. It also introduces odorant, so **gas leaks can be detected** throughout the system. **Methane emissions** at gate station usually come from venting during normal valve operation and leaks in equipment components.

## Solutions

- Tartarini Type DO200
- Fisher V200 Ball Valve with Low Bleed DVC
- Fisher easy-E ET Globe Valve with ENVIRO-SEAL packing and Low Bleed DVC
- Anderson Greenwood Series 400 with Monitoring
- Bettis RTS FQ
- Bettis G-Series Actuator
- Fisher EZH
- RNG Injection and H2 Blending
- Fisher EZHOSX
- Tartarini FL with SRS
- Fisher EZHSO

## Fisher™ EZHOSX



EZHOSX is an accurate, pilot-operated, pressure balanced, soft seated regulator and is designed for use in city gate stations. The integral slam-shut functionality serves to discontinue gas service by shutting the gas off if there is an overpressure or under pressure condition.

*Fisher EZHOSX*  
Product information

## Emissions Reduction Opportunities

The integral slam-shut in the EZHOSX helps minimize fugitive emissions during overpressure and under pressure conditions.

# DISTRIBUTION – CITY GATE / CUSTODY TRANSFER

- City Gate / Custody Transfer
- Meter Applications
- LNG
- District Regulator Station
- Power Plant Feed

City gate stations are primary handoff locations, found between Natural Gas Transmission and Distribution companies. The stations are designed to reduce the pressure differences between the two systems, provide to provide accurate measurement, and record the transaction. It also introduces odorant, so **gas leaks can be detected** throughout the system. **Methane emissions** at gate station usually come from venting during normal valve operation and leaks in equipment components.

## Solutions

- Tartarini Type DO200
- Fisher V200 Ball Valve with Low Bleed DVC
- Anderson Greenwood Series 400 with Monitoring
- Bettis RTS FQ
- Bettis G-Series Actuator
- Fisher EZH
- RNG Injection and H2 Blending
- Fisher EZHOSX
- Tartarini FL with SRS
- Fisher EZHSO

## Fisher™ EZHSO

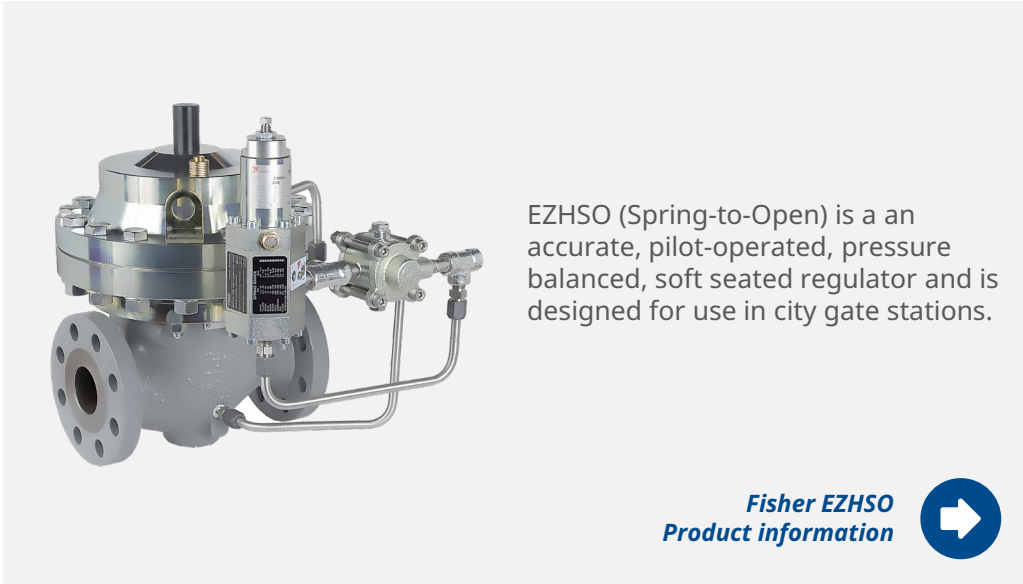

## Emissions Reduction Opportunities

EZH Series regulators eliminate bleed gas to atmosphere by utilizing a self-contained control system, which bleeds 100% of the gas to the downstream system.



# DISTRIBUTION – CITY GATE / CUSTODY TRANSFER

-  City Gate / Custody Transfer
-  Meter Applications
-  LNG
-  District Regulator Station
-  Power Plant Feed

City gate stations are primary handoff locations, found between Natural Gas Transmission and Distribution companies. The stations are designed to reduce the pressure differences between the two systems, provide to provide accurate measurement, and record the transaction. It also introduces odorant, so **gas leaks can be detected** throughout the system. **Methane emissions** at gate station usually come from venting during normal valve operation and leaks in equipment components.

## Solutions

-  Tartarini Type DO200
-  Fisher V200 Ball Valve with Low Bleed DVC
-  Fisher easy-E ET Globe Valve with ENVIRO-SEAL packing and Low Bleed DVC
-  Anderson Greenwood Series 400 with Monitoring
-  Bettis RTS FQ
-  Bettis G-Series Actuator
-  Fisher EZH
-  RNG Injection and H2 Blending
-  Fisher EZHOSX
-  Tartarini FL with SRS
-  Fisher EZHSO

## Fisher™ V200 Ball Valve with Low Bleed DVC



The Fisher Vee-Ball V200 control valve provides performance and cost-effectiveness across a broad range of applications. The precision-machined parts and pressure balanced seal designs allow smooth, precise valve operation. ENVIRO-SEAL™ packing systems that provide an improved stem seal to help prevent the loss of process fluid are available.

*Fisher V200 Ball Valve with Low Bleed DVC*  **Product information**

## Emissions Reduction Opportunities

The DVC6200 Series digital valve controllers equipped with a low bleed relay will meet the Quad-O steady-state consumption requirement of 6 scfh when used with up to a maximum 3.7 bar / 53 psi natural gas supply at 16°C. The excellent stem sealing of the ENVIRO-SEAL packing system controls emissions to below the EPA minimum of 100 ppm (parts per million).

# DISTRIBUTION – CITY GATE / CUSTODY TRANSFER

- City Gate / Custody Transfer
- Meter Applications
- LNG
- District Regulator Station
- Power Plant Feed

City gate stations are primary handoff locations, found between Natural Gas Transmission and Distribution companies. The stations are designed to reduce the pressure differences between the two systems, provide to provide accurate measurement, and record the transaction. It also introduces odorant, so **gas leaks can be detected** throughout the system. **Methane emissions** at gate station usually come from venting during normal valve operation and leaks in equipment components.

## Solutions

- Tartarini Type DO200
- Fisher V200 Ball Valve with Low Bleed DVC
- Fisher easy-E ET Globe Valve with ENVIRO-SEAL packing and Low Bleed DVC
- Anderson Greenwood Series 400 with Monitoring
- Bettis RTS FQ
- Bettis G-Series Actuator
- Fisher EZH
- RNG Injection and H2 Blending
- Fisher EZHOSX
- Tartarini FL with SRS
- Fisher EZHSO

## Anderson Greenwood™ Series 400 with Monitoring



A non-flowing, fully modulating pilot operated pressure relief valve, the Series 400 is ideal on natural gas applications. Monitoring PRVs provides real-time information enabling you to proactively develop proper corrective action, optimize maintenance schedules and improve asset management while ensuring regulatory compliance.

Anderson Greenwood Series 400 with Monitoring Product information



## Emissions Reduction Opportunities

Best in class seat tightness (fugitive emissions if venting to atmosphere). Balanced against backpressure with no need for fragile bellows that can create large fugitive emissions concerns. PRV Monitoring can tell you when a valve opened, the timestamp and duration of that event, aid in the calculation of a volumetric release, and even give feedback as to whether a valve is leaking.



# DISTRIBUTION – CITY GATE / CUSTODY TRANSFER

- City Gate / Custody Transfer
- Meter Applications
- LNG
- District Regulator Station
- Power Plant Feed

City gate stations are primary handoff locations, found between Natural Gas Transmission and Distribution companies. The stations are designed to reduce the pressure differences between the two systems, provide to provide accurate measurement, and record the transaction. It also introduces odorant, so **gas leaks can be detected** throughout the system. **Methane emissions** at gate station usually come from venting during normal valve operation and leaks in equipment components.

## Solutions

- Tartarini Type DO200
- Fisher V200 Ball Valve with Low Bleed DVC
- Fisher easy-E ET Globe Valve with ENVIRO-SEAL packing and Low Bleed DVC
- Anderson Greenwood Series 400 with Monitoring
- Bettis RTS FQ
- Bettis G-Series Actuator
- Fisher EZH
- RNG Injection and H2 Blending
- Fisher EZHOSX
- Tartarini FL with SRS
- Fisher EZHSO

## Bettis™ G-Series



The Bettis G-Series pneumatic, scotch yoke, valve actuator is a highly unique and reliable actuator for operating ball, butterfly or plug valves along with louvers, dampers and other 90 degree rotating mechanisms. Suitable for use in demanding SIL-required applications.

*Bettis G-Series Product information*

## Emissions Reduction Opportunities

The G-Series Scotch Yoke actuator can be fit with zero/low bleed controller or powered by instrument air to provide zero/low emissions operation during loss of power event to worker control valve.

# DISTRIBUTION – CITY GATE / CUSTODY TRANSFER

- City Gate / Custody Transfer
- Meter Applications
- LNG
- District Regulator Station
- Power Plant Feed

City gate stations are primary handoff locations, found between Natural Gas Transmission and Distribution companies. The stations are designed to reduce the pressure differences between the two systems, provide to provide accurate measurement, and record the transaction. It also introduces odorant, so **gas leaks can be detected** throughout the system. **Methane emissions** at gate station usually come from venting during normal valve operation and leaks in equipment components.

## Solutions

- Tartarini Type DO200
- Fisher V200 Ball Valve with Low Bleed DVC
- Anderson Greenwood Series 400 with Monitoring
- Bettis RTS FQ
- Bettis G-Series Actuator
- Fisher EZH
- RNG Injection and H2 Blending
- Fisher EZHOSX
- Tartarini FL with SRS
- Fisher EZHSO

## RNG Injection and H2 Blending

For natural gas utilities, the blending of hydrogen in the existing distribution network is accelerating the transition to a carbon neutral energy supply. Emerson offers a complete portfolio of solutions that address the challenges of hydrogen service and blending hydrogen in natural gas pipelines, including odorant injection, pressure regulation, pressure relief valves, flow control valves, custody transfer measurement and control, gas analysis, flow measurement and energy software solutions.

Renewable Natural Gas (RNG) or Biomethane is an alternative to natural gas. It can be used in multiple applications (heat, power generation, industrial feedstock, transportation fuel) and is an effective way to reduce total emissions across the whole value chain. Utilities and developers face the challenge of bringing new biomethane projects into their distribution systems, on time and within budget. Emerson offers a complete portfolio of solutions that address all your RNG injection skid requirements, including custody transfer measurement and control, odorant injection, gas analysis, flow measurement and pressure control.

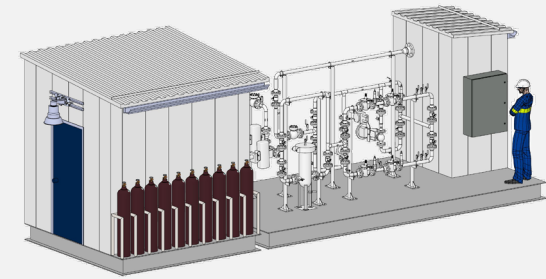

RNG Injection and H2 Blending Product information

## Emissions Reduction Opportunities

Emerson solutions in RNG injection help minimize methane emissions through use of no bleed technologies and solutions that perform at optimal efficiency and maximum uptime.

Emerson solutions in hydrogen applications help accelerate the evolution towards more carbon neutral energy supply through use of materials and solutions that are designed for various levels of hydrogen service.

# DISTRIBUTION – CITY GATE / CUSTODY TRANSFER

- City Gate / Custody Transfer
- Meter Applications
- LNG
- District Regulator Station
- Power Plant Feed

City gate stations are primary handoff locations, found between Natural Gas Transmission and Distribution companies. The stations are designed to reduce the pressure differences between the two systems, provide to provide accurate measurement, and record the transaction. It also introduces odorant, so **gas leaks can be detected** throughout the system. **Methane emissions** at gate station usually come from venting during normal valve operation and leaks in equipment components.

## Solutions

- Tartarini Type DO200
- Fisher V200 Ball Valve with Low Bleed DVC
- Fisher easy-E ET Globe Valve with ENVIRO-SEAL packing and Low Bleed DVC
- Anderson Greenwood Series 400 with Monitoring
- Bettis RTS FQ
- Bettis G-Series Actuator
- Fisher EZH
- RNG Injection and H2 Blending
- Fisher EZHOSX
- Tartarini FL with SRS
- Fisher EZHSO

## Tartarini™ FL with SRS

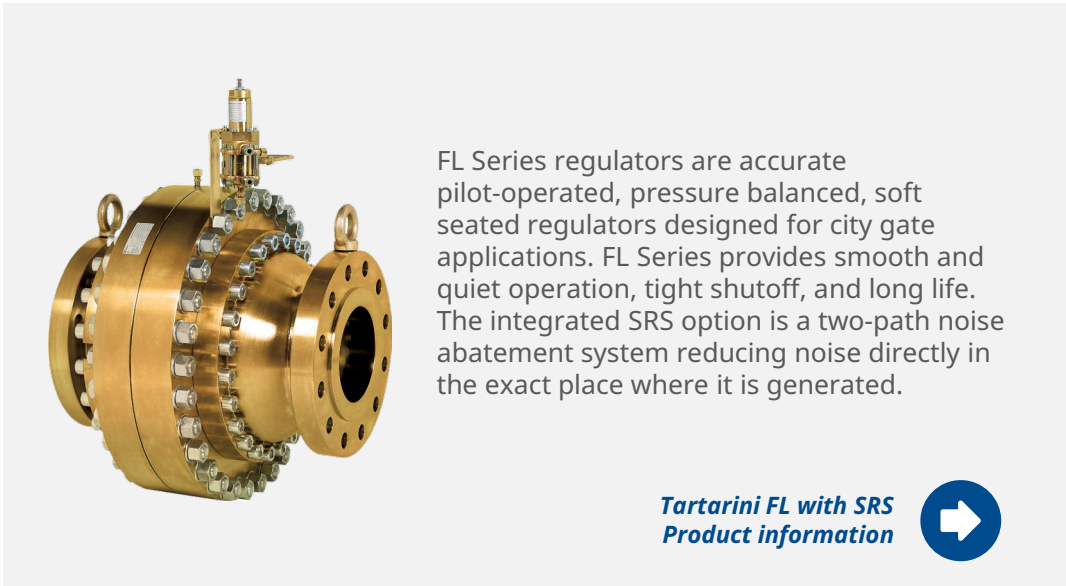

FL Series regulators are accurate pilot-operated, pressure balanced, soft seated regulators designed for city gate applications. FL Series provides smooth and quiet operation, tight shutoff, and long life. The integrated SRS option is a two-path noise abatement system reducing noise directly in the exact place where it is generated.

*Tartarini FL with SRS Product information*

## Emissions Reduction Opportunities







FL Series regulators eliminate bleed gas to atmosphere by utilizing a self-contained control system, which bleeds 100% of the gas to the downstream system.

# DISTRIBUTION – DISTRICT REGULATOR STATION

-  City Gate / Custody Transfer
-  Meter Applications
-  LNG
-  District Regulator Station
-  Power Plant Feed

From the city gate, the gas pressure drops (or regulates) to safer pressure before flowing to the distribution pipeline network to district stations. These district stations are similar to city gates but are smaller in size with lower pressures. Within the distribution network **leak prone pipe is a common source of fugitive emissions.**

## Solutions

-  Fisher EZHSO
-  Fisher LSR
-  Fisher EZL
-  Fisher Type OSE Slam-Shut
-  Fisher EZLOSX
-  Fisher Type VS100 Slam-Shut
-  Anderson Greenwood Series 400 PRV with High Gain Modulating Action and PRV Monitoring

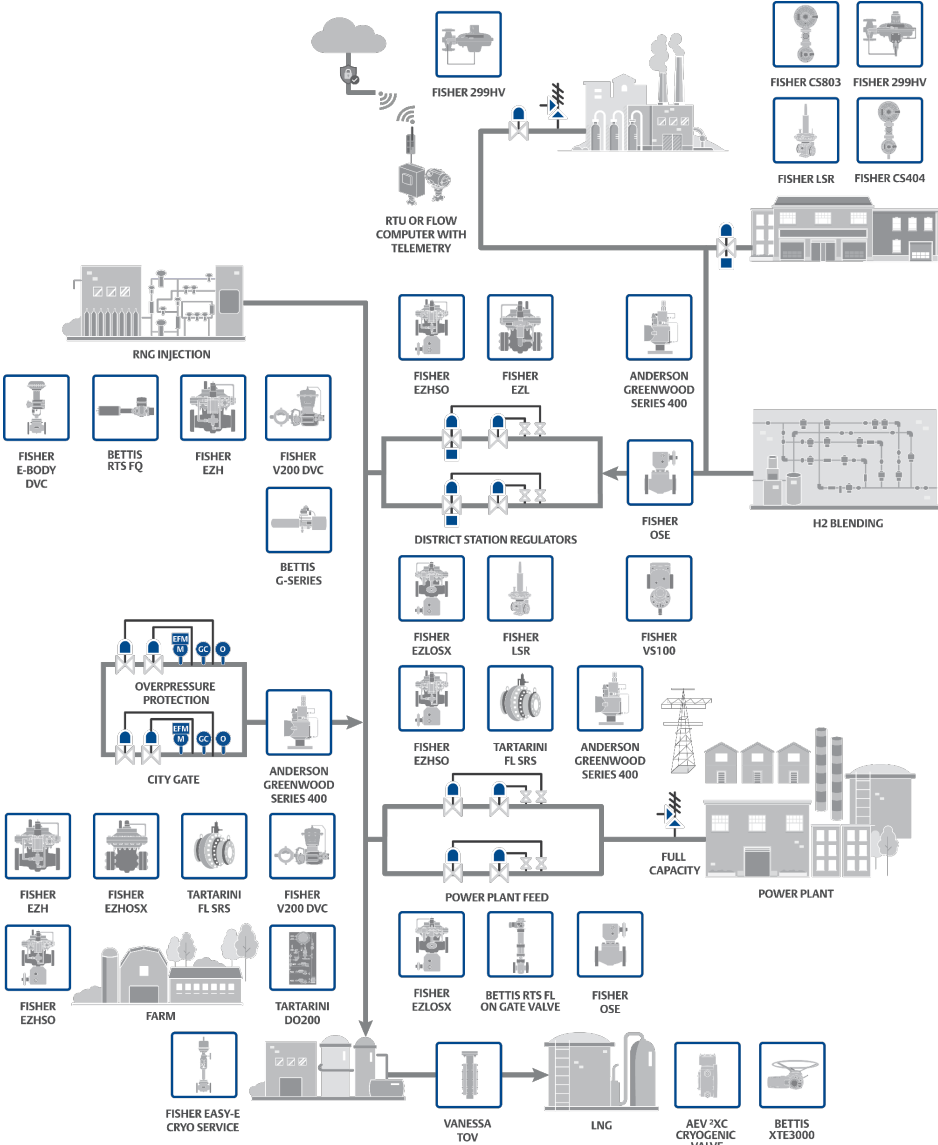

# DISTRIBUTION – DISTRICT REGULATOR STATION

- City Gate / Custody Transfer
- Meter Applications
- LNG
- District Regulator Station**
- Power Plant Feed

From the city gate, the gas pressure drops (or regulates) to safer pressure before flowing to the distribution pipeline network to district stations. These district stations are similar to city gates but are smaller in size with lower pressures. Within the distribution network **leak prone pipe is a common source of fugitive emissions.**

## Solutions

- Fisher EZHSO
- Fisher EZL
- Fisher EZLOSX
- Anderson Greenwood Series 400 PRV with High Gain Modulating Action and PRV Monitoring
- Fisher LSR
- Fisher Type OSE Slam-Shut
- Fisher Type VS100 Slam-Shut

## Fisher™ EZHSO

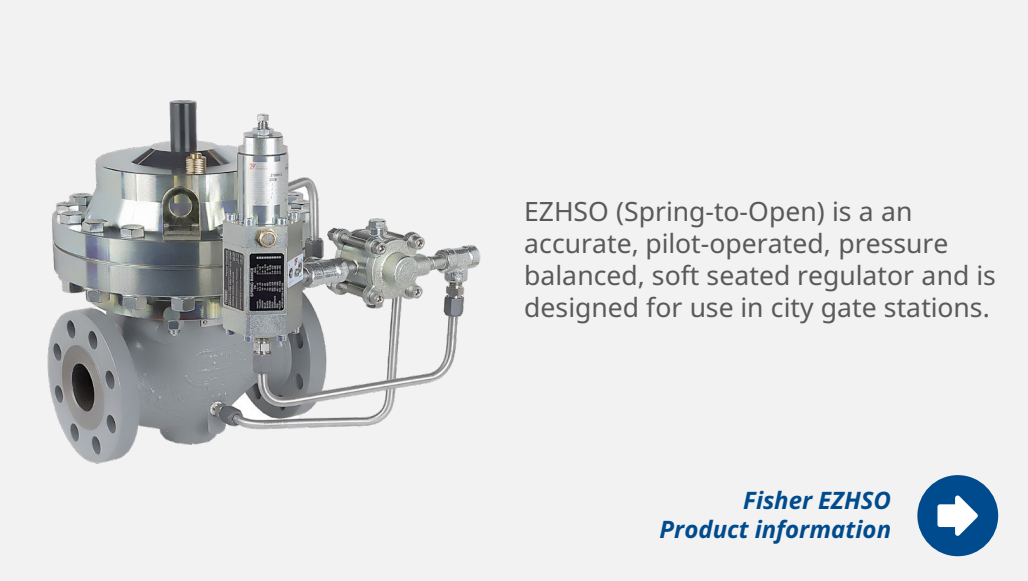

## Emissions Reduction Opportunities

EZH Series regulators eliminate bleed gas to atmosphere by utilizing a self-contained control system, which bleeds 100% of the gas to the downstream system.

# DISTRIBUTION – DISTRICT REGULATOR STATION

- City Gate / Custody Transfer
- Meter Applications
- LNG
- District Regulator Station**
- Power Plant Feed

From the city gate, the gas pressure drops (or regulates) to safer pressure before flowing to the distribution pipeline network to district stations. These district stations are similar to city gates but are smaller in size with lower pressures. Within the distribution network **leak prone pipe is a common source of fugitive emissions.**

## Solutions

- Fisher EZHSO
- Fisher EZL
- Fisher EZLOSX
- Anderson Greenwood Series 400 PRV with High Gain Modulating Action and PRV Monitoring**
- Fisher LSR
- Fisher Type OSE Slam-Shut
- Fisher Type VS100 Slam-Shut

## Fisher™ EZL



Fisher EZL Series regulators are accurate pilot-operated, pressure balanced, soft-seated regulators. They are designed for use in district regulator stations. They provide low differential, smooth, reliable operation, tight shutoff and long life.

*Fisher EZL*  
Product information 

## Emissions Reduction Opportunities

EZL Series regulators eliminate bleed gas to atmosphere by utilizing a self-contained control system, which bleeds 100% of the gas to the downstream system.



# DISTRIBUTION – DISTRICT REGULATOR STATION

- City Gate / Custody Transfer
- Meter Applications
- LNG
- District Regulator Station**
- Power Plant Feed

From the city gate, the gas pressure drops (or regulates) to safer pressure before flowing to the distribution pipeline network to district stations. These district stations are similar to city gates but are smaller in size with lower pressures. Within the distribution network **leak prone pipe is a common source of fugitive emissions.**

## Solutions

- Fisher EZHSO
- Fisher EZL
- Fisher EZLOSX
- Anderson Greenwood Series 400 PRV with High Gain Modulating Action and PRV Monitoring
- Fisher LSR
- Fisher Type OSE Slam-Shut
- Fisher Type VS100 Slam-Shut

## Fisher™ EZLOSX

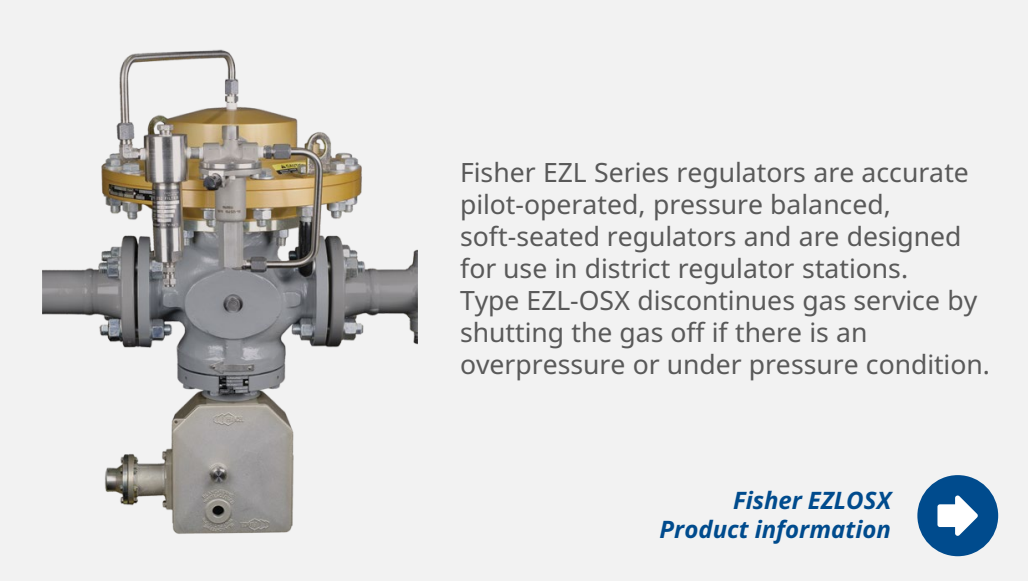

## Emissions Reduction Opportunities

The integral slam-shut in the EZLOSX helps minimize fugitive emissions during overpressure and under pressure conditions.

## DISTRIBUTION – DISTRICT REGULATOR STATION

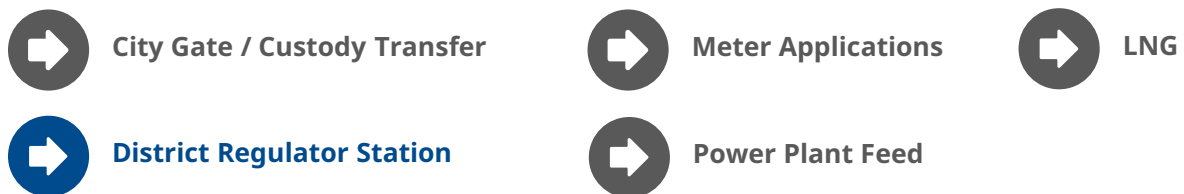

From the city gate, the gas pressure drops (or regulates) to safer pressure before flowing to the distribution pipeline network to district stations. These district stations are similar to city gates but are smaller in size with lower pressures. Within the distribution network **leak prone pipe is a common source of fugitive emissions.**

### Solutions



### Anderson Greenwood™ Series 400 PRV with High Gain Modulating Action and PRV Monitoring



A non-flowing, fully modulating pilot operated pressure relief valve, the Series 400 is ideal on natural gas applications. Monitoring PRVs provides real-time information enabling you to proactively develop proper corrective action, optimize maintenance schedules and improve asset management while ensuring regulatory compliance.

*Anderson Greenwood Series 400 PRV with High Gain Modulating Action and PRV Monitoring Product information*



### Emissions Reduction Opportunities

Modulating action minimizes fugitive emissions, product release, product loss, and noise by ensuring a fully proportional opening while providing a stable operation even with high inlet losses. Best in class seat tightness (fugitive emissions if venting to atmosphere). Balanced against backpressure with no need for fragile bellows that can create large fugitive emissions concerns. PRV Monitoring can tell you when a valve opened, the timestamp and duration of that event, aid in the calculation of a volumetric release, and even give feedback as to whether a valve is leaking.



# DISTRIBUTION – DISTRICT REGULATOR STATION

- City Gate / Custody Transfer
- Meter Applications
- LNG
- District Regulator Station**
- Power Plant Feed

From the city gate, the gas pressure drops (or regulates) to safer pressure before flowing to the distribution pipeline network to district stations. These district stations are similar to city gates but are smaller in size with lower pressures. Within the distribution network **leak prone pipe is a common source of fugitive emissions.**

## Solutions

- Fisher EZHSO
- Fisher EZL
- Fisher EZLOSX
- Anderson Greenwood Series 400 PRV with High Gain Modulating Action and PRV Monitoring
- Fisher LSR
- Fisher Type OSE Slam-Shut
- Fisher Type VS100 Slam-Shut

## Fisher™ LSR



The LSR is a self-operated balanced trim regulator that provides best in class flow performance and is used in natural gas district station systems.

*Fisher LSR*  
*Product information*

## Emissions Reduction Opportunities

The LSR has a selectable slam-shut option that when used enables zero emissions operation by eliminating leaking and venting of natural gas to atmosphere.

# DISTRIBUTION – DISTRICT REGULATOR STATION

- City Gate / Custody Transfer
- Meter Applications
- LNG
- District Regulator Station**
- Power Plant Feed

From the city gate, the gas pressure drops (or regulates) to safer pressure before flowing to the distribution pipeline network to district stations. These district stations are similar to city gates but are smaller in size with lower pressures. Within the distribution network **leak prone pipe is a common source of fugitive emissions.**

## Solutions

- Fisher EZHSO
- Fisher EZL
- Fisher EZLOSX
- Anderson Greenwood Series 400 PRV with High Gain Modulating Action and PRV Monitoring**
- Fisher LSR
- Fisher Type OSE Slam-Shut**
- Fisher Type VS100 Slam-Shut

## Fisher™ Type OSE Slam-Shut



Type OSE slam-shut valve is used to rapidly cut the gas flow during an overpressure or under pressure event. It is ideal for gas applications requiring positive shut-off protection, tight accuracy, fast speed of response, and high shock and vibration resistance. The top entry design makes in-line maintenance easy, saving time and manpower requirements.

*Fisher Type OSE Slam-Shut Product information*

## Emissions Reduction Opportunities

Use of the Type OSE slam-shut valve enables zero emissions operation by eliminating leaking and venting of natural gas to atmosphere.

# DISTRIBUTION – DISTRICT REGULATOR STATION

- City Gate / Custody Transfer
- Meter Applications
- LNG
- District Regulator Station**
- Power Plant Feed

From the city gate, the gas pressure drops (or regulates) to safer pressure before flowing to the distribution pipeline network to district stations. These district stations are similar to city gates but are smaller in size with lower pressures. Within the distribution network **leak prone pipe is a common source of fugitive emissions.**

## Solutions

- Fisher EZHSO
- Fisher LSR
- Fisher EZL
- Fisher Type OSE Slam-Shut
- Fisher EZLOSX
- Fisher Type VS100 Slam-Shut
- Anderson Greenwood Series 400 PRV with High Gain Modulating Action and PRV Monitoring**

## Fisher™ Type VS100 Slam-Shut

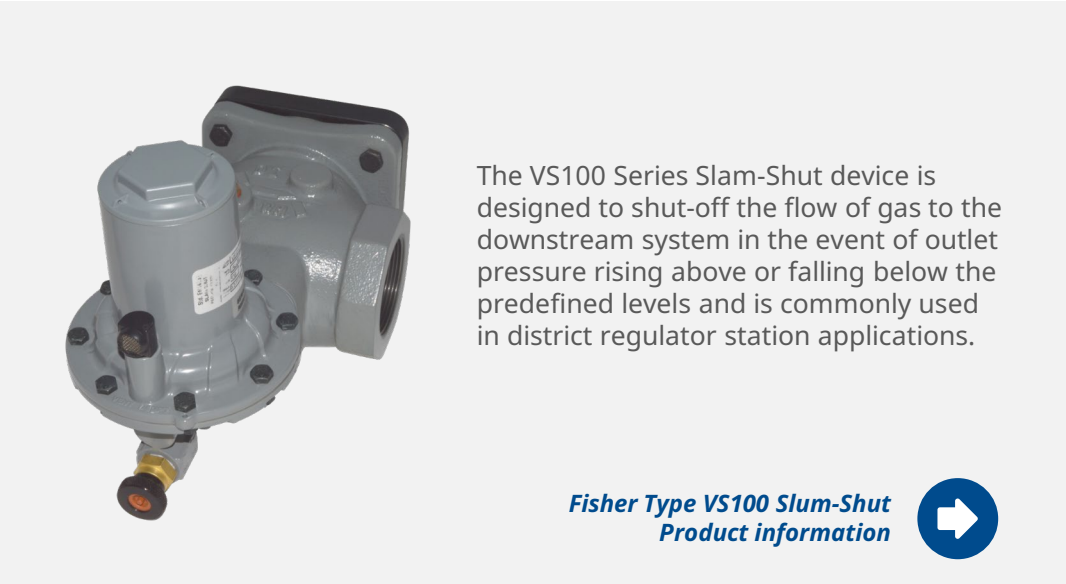

## Emissions Reduction Opportunities

Use of the Type VS100 slam-shut valve enables zero emissions operation by eliminating leaking and venting of natural gas to atmosphere.

# DISTRIBUTION – METER APPLICATIONS

- ➔ City Gate / Custody Transfer
- ➔ Meter Applications
- ➔ LNG
- ➔ District Regulator Station
- ➔ Power Plant Feed

Mechanical or digital volume correctors (or flow meters) measure the gas volume flowing to a customer or a group of customers. Over time, these meter sets are prone to corrosion which gives way to leaks of various sizes that make way for **fugitive emissions**.

## Solutions

- ➔ Fisher Type 299HV
- ➔ Fisher Type CS404
- ➔ Fisher Type CS803
- ➔ Fisher LSR with Slam-Shut

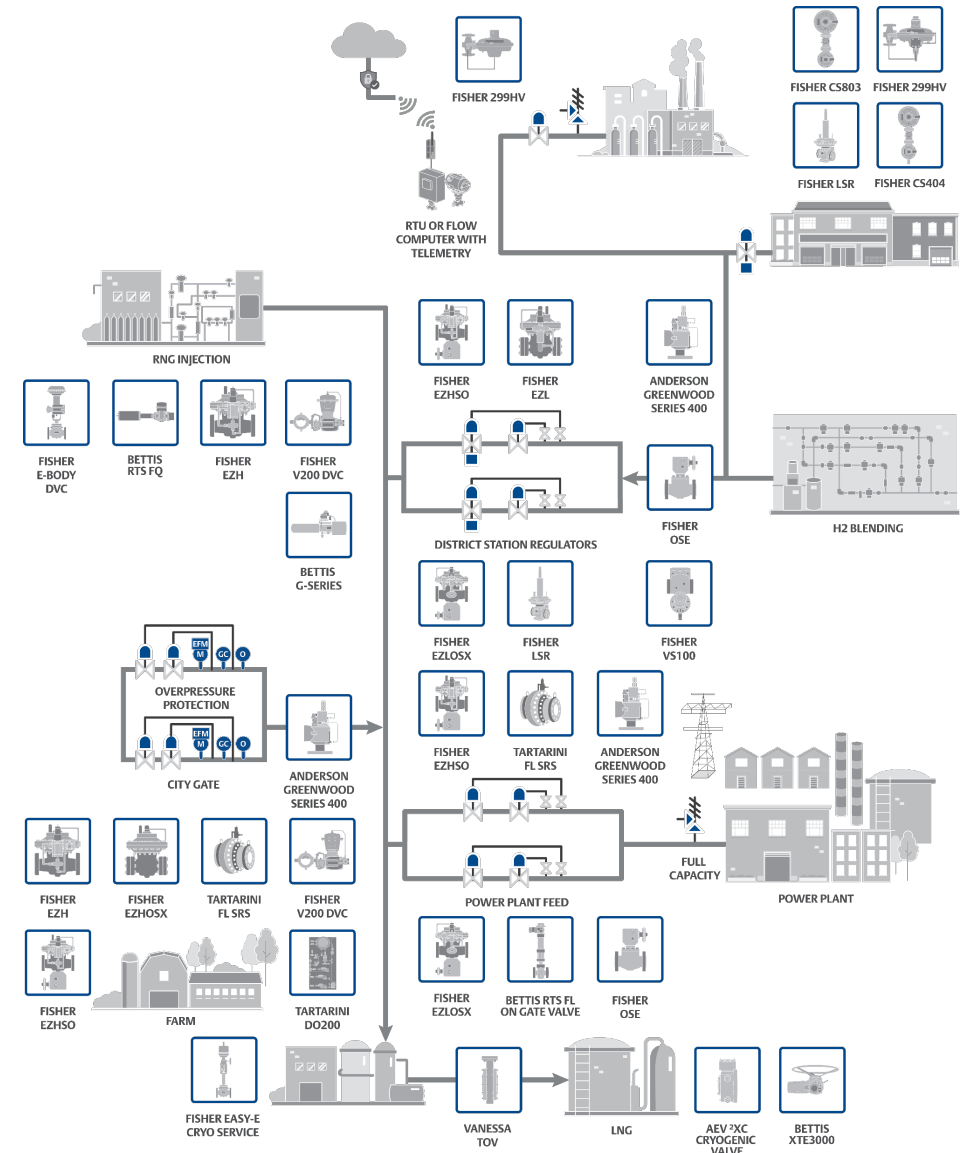

## DISTRIBUTION – METER APPLICATIONS

- City Gate / Custody Transfer
- Meter Applications
- LNG
- District Regulator Station
- Power Plant Feed

Mechanical or digital volume correctors (or flow meters) measure the gas volume flowing to a customer or a group of customers. Over time, these meter sets are prone to corrosion which gives way to leaks of various sizes that make way for **fugitive emissions**.

### Solutions

- Fisher Type 299HV
- Fisher Type CS404
- Fisher Type CS803
- Fisher LSR with Slam-Shut

### Fisher™ Type 299HV



Fisher 299H Series pilot operated pressure reducing regulators provide controlled pressure and capacities for distribution, industrial and commercial applications with inlet pressures up to 175 psi / 12.1 bar. Type 299HV with Type VSX8 are used in applications where the gas supply must be shut-off.

*Fisher Type 299HV  
Product information*

### Emissions Reduction Opportunities

The Type 299H series has a unique no bleed monitor system to enable zero emission operations by eliminating venting of natural gas to atmosphere or downstream piping. Use of the slam-shut valve in the 299HV enables zero emissions operation by eliminating leaking and venting of natural gas to atmosphere.



## DISTRIBUTION – METER APPLICATIONS

- City Gate / Custody Transfer
- Meter Applications
- LNG
- District Regulator Station
- Power Plant Feed

Mechanical or digital volume correctors (or flow meters) measure the gas volume flowing to a customer or a group of customers. Over time, these meter sets are prone to corrosion which gives way to leaks of various sizes that make way for **fugitive emissions**.

### Solutions

- Fisher Type 299HV
- Fisher Type CS404
- Fisher Type CS803
- Fisher LSR with Slam-Shut

### Fisher™ Type CS404

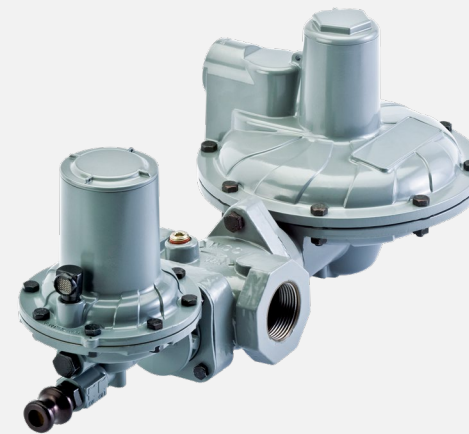

Fisher CS400 Series direct-operated, spring-loaded regulators provide pressure-reducing applications for commercial and light industrial installations. This flexibility is provided by the numerous body sizes and end connections, outlet pressure settings, orifice sizes, as well as the option for internal or external pressure registration. The Type CS404 offers a slam-shut module that shuts off the flow of gas to the downstream system in the event of outlet pressure rising above or falling below the predefined levels.

*Fisher Type CS404  
Product information*

### Emissions Reduction Opportunities

Use of the slam-shut valve in the Type CS404 enables zero emissions operation by eliminating leaking and venting of natural gas to atmosphere.





## DISTRIBUTION – METER APPLICATIONS

- City Gate / Custody Transfer
- Meter Applications
- LNG
- District Regulator Station
- Power Plant Feed

Mechanical or digital volume correctors (or flow meters) measure the gas volume flowing to a customer or a group of customers. Over time, these meter sets are prone to corrosion which gives way to leaks of various sizes that make way for **fugitive emissions**.

### Solutions

- Fisher Type 299HV
- Fisher Type CS404
- Fisher Type CS803
- Fisher LSR with Slam-Shut

### Fisher™ Type CS803



The Fisher Type CS803 Series regulator with True Monitor Protection has been engineered to provide the operation of a conventional two-regulator wide-open monitor set into one compact device without the need for a downstream control line. With an increased outlet pressure range and reduced downstream pressure buildup, this generation offers significant performance gains while at the same time offering installation ease with simplified setpoint adjustment and the flexibility of dual axis vent rotation. Performance and versatility translate into reduced cost of installation, from time-saving installation, to eliminating piping and control lines, to a reduced overall meter set footprint.

*Fisher Type CS803  
Product information*



### Emissions Reduction Opportunities

Using the Type CS803 eliminates the emissions associated with an external relief valve.



## DISTRIBUTION – METER APPLICATIONS

- City Gate / Custody Transfer
- Meter Applications
- LNG
- District Regulator Station
- Power Plant Feed

Mechanical or digital volume correctors (or flow meters) measure the gas volume flowing to a customer or a group of customers. Over time, these meter sets are prone to corrosion which gives way to leaks of various sizes that make way for **fugitive emissions**.

### Solutions

- Fisher Type 299HV
- Fisher Type CS404
- Fisher Type CS803
- Fisher LSR with Slam-Shut

### Fisher™ LSR with Slam-Shut



The LSR is a self-operated balanced trim regulator that provides best in class flow performance and is used in natural gas district station systems. The LSR has a selectable slam-shut option that discontinues gas service by shutting the gas off if there is an overpressure or under pressure condition.

*Fisher LSR with Slam-Shut  
Product information*







### Emissions Reduction Opportunities

Use of the slam-shut option enables zero emissions operation by eliminating leaking and venting of natural gas to atmosphere.



# DISTRIBUTION – POWER PLANT FEED

-  City Gate / Custody Transfer
-  Meter Applications
-  LNG
-  District Regulator Station
-  Power Plant Feed

Natural gas-fired power plants typically source gas from a nearby transmission pipeline which can operate at pressures from 200 psig to over 1000 psig. These high pressures, along with high flow required to feed the plant, require the installation of large, pilot-operated pressure reducing regulators, or control valves at the pressure reduction stations that feed the plant.

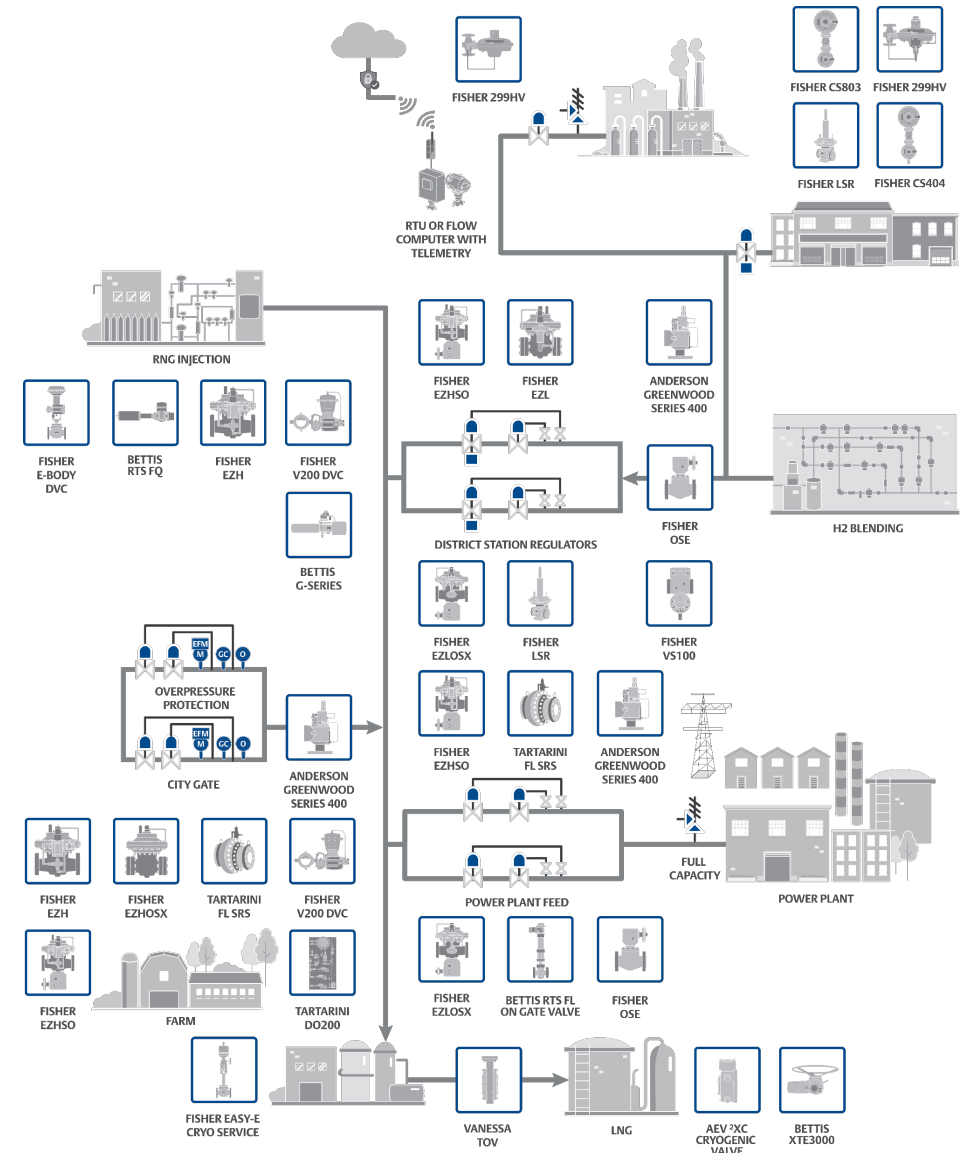

## Solutions

-  Fisher EZHSO
-  Bettis RTS FL
-  Fisher EZLOSX
-  Tartarini FL with SRS
-  Fisher Type OSE Slam-Shut
-  Anderson Greenwood Series 400 with Monitoring



## DISTRIBUTION – POWER PLANT FEED

- City Gate / Custody Transfer
- Meter Applications
- LNG
- District Regulator Station
- Power Plant Feed**

Natural gas-fired power plants typically source gas from a nearby transmission pipeline which can operate at pressures from 200 psig to over 1000 psig. These high pressures, along with high flow required to feed the plant, require the installation of large, pilot-operated pressure reducing regulators, or control valves at the pressure reduction stations that feed the plant.

### Solutions

- Fisher EZHSO
- Bettis RTS FL
- Fisher EZLOSX
- Tartarini FL with SRS
- Fisher Type OSE Slam-Shut
- Anderson Greenwood Series 400 with Monitoring

### Fisher™ EZHSO

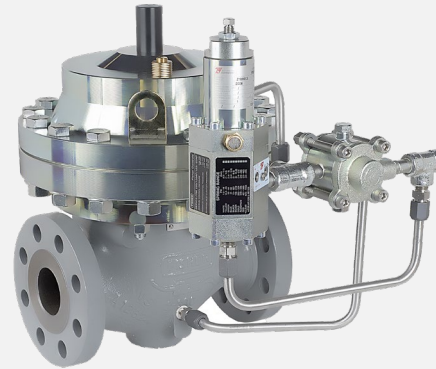

EZHSO (Spring-to-Open) is an accurate, pilot-operated, pressure balanced, soft seated regulator and is designed for use in city gate stations.

*Fisher EZHSO  
Product information*



### Emissions Reduction Opportunities

EZH Series regulators eliminate bleed gas to atmosphere by utilizing a self-contained control system, which bleeds 100% of the gas to the downstream system.



## DISTRIBUTION – POWER PLANT FEED

- City Gate / Custody Transfer
- Meter Applications
- LNG
- District Regulator Station
- Power Plant Feed**

Natural gas-fired power plants typically source gas from a nearby transmission pipeline which can operate at pressures from 200 psig to over 1000 psig. These high pressures, along with high flow required to feed the plant, require the installation of large, pilot-operated pressure reducing regulators, or control valves at the pressure reduction stations that feed the plant.

### Solutions

- Fisher EZHSO
- Bettis RTS FL
- Fisher EZLOSX
- Tartarini FL with SRS
- Fisher Type OSE Slam-Shut
- Anderson Greenwood Series 400 with Monitoring**

### Fisher™ EZLOSX

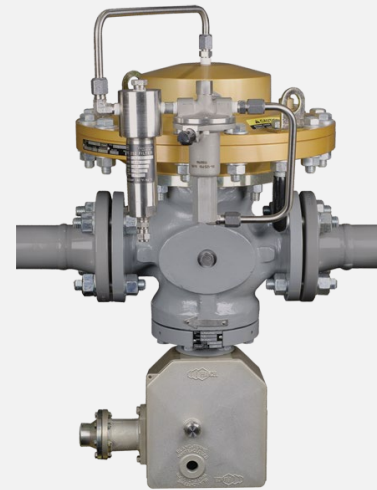

Fisher EZL Series regulators are accurate pilot-operated, pressure balanced, soft-seated regulators and are designed for use in district regulator stations. Type EZL-OSX discontinues gas service by shutting the gas off if there is an overpressure or under pressure condition.

*Fisher EZLOSX  
Product information*



### Emissions Reduction Opportunities

The integral slam-shut in the EZLOSX helps minimize fugitive emissions during overpressure and under pressure conditions.



## DISTRIBUTION – POWER PLANT FEED

- City Gate / Custody Transfer
- Meter Applications
- LNG
- District Regulator Station
- Power Plant Feed**

Natural gas-fired power plants typically source gas from a nearby transmission pipeline which can operate at pressures from 200 psig to over 1000 psig. These high pressures, along with high flow required to feed the plant, require the installation of large, pilot-operated pressure reducing regulators, or control valves at the pressure reduction stations that feed the plant.

### Solutions

- Fisher EZHSO
- Bettis RTS FL
- Fisher EZLOSX
- Tartarini FL with SRS
- Fisher Type OSE Slam-Shut**
- Anderson Greenwood Series 400 with Monitoring**

### Fisher™ Type OSE Slam-Shut



Type OSE slam-shut valve is used to rapidly cut the gas flow during an overpressure or under pressure event. It is ideal for gas applications requiring positive shutoff protection, tight accuracy, fast speed of response, and high shock and vibration resistance. The top entry design makes in-line maintenance easy, saving time and manpower requirements.

*Fisher Type OSE Slam-Shut  
Product information*



### Emissions Reduction Opportunities

Use of the Type OSE slam-shut valve enables zero emissions operation by eliminating leaking and venting of natural gas to atmosphere.



## DISTRIBUTION – POWER PLANT FEED

- City Gate / Custody Transfer
- Meter Applications
- LNG
- District Regulator Station
- Power Plant Feed**

Natural gas-fired power plants typically source gas from a nearby transmission pipeline which can operate at pressures from 200 psig to over 1000 psig. These high pressures, along with high flow required to feed the plant, require the installation of large, pilot-operated pressure reducing regulators, or control valves at the pressure reduction stations that feed the plant.

### Solutions

- Fisher EZHSO
- Fisher EZLOSX
- Fisher Type OSE Slam-Shut
- Bettis RTS FL
- Tartarini FL with SRS
- Anderson Greenwood Series 400 with Monitoring**

### Bettis™ RTS FL



A non-intrusive intelligent fail-safe linear actuator for ON/OFF and modulation control in fail-safe applications. The robust and compact mechanical spring-return design can be triggered to fail-safe action either on loss of power or signal. With no dependency on super-capacitor or battery-backup, this state-of-the-art design is widely used on valves for energy applications.

*Bettis RTS FL*  
Product information



### Emissions Reduction Opportunities

Fail-safe Electric Linear Actuation can eliminate vented methane from valve operation.



## DISTRIBUTION – POWER PLANT FEED

- City Gate / Custody Transfer
- Meter Applications
- LNG
- District Regulator Station
- Power Plant Feed

Natural gas-fired power plants typically source gas from a nearby transmission pipeline which can operate at pressures from 200 psig to over 1000 psig. These high pressures, along with high flow required to feed the plant, require the installation of large, pilot-operated pressure reducing regulators, or control valves at the pressure reduction stations that feed the plant.

### Solutions

- Fisher EZHSO
- Bettis RTS FL
- Fisher EZLOSX
- Tartarini FL with SRS
- Fisher Type OSE Slam-Shut
- Anderson Greenwood Series 400 with Monitoring

### Tartarini™ FL with SRS



FL Series regulators are accurate pilot-operated, pressure balanced, soft seated regulators designed for power plant feed applications. FL Series provides smooth and quiet operation, tight shutoff, and long life. The integrated SRS option is a two-path noise abatement system reducing noise directly in the exact place where it is generated.

*Tartarini FL with SRS  
Product information*



### Emissions Reduction Opportunities

FL Series regulators eliminate bleed gas to atmosphere by utilizing a self-contained control system, which bleeds 100% of the gas to the downstream system.





## DISTRIBUTION – POWER PLANT FEED

- City Gate / Custody Transfer
- Meter Applications
- LNG
- District Regulator Station
- Power Plant Feed

Natural gas-fired power plants typically source gas from a nearby transmission pipeline which can operate at pressures from 200 psig to over 1000 psig. These high pressures, along with high flow required to feed the plant, require the installation of large, pilot-operated pressure reducing regulators, or control valves at the pressure reduction stations that feed the plant.

### Solutions

- Fisher EZHSO
- Bettis RTS FL
- Fisher EZLOSX
- Tartarini FL with SRS
- Fisher Type OSE Slam-Shut
- Anderson Greenwood Series 400 with Monitoring

### Anderson Greenwood™ Series 400 with Monitoring



A non-flowing, fully modulating pilot operated pressure relief valve, the Series 400 is ideal on natural gas applications. Monitoring PRVs provides real-time information enabling you to proactively develop proper corrective action, optimize maintenance schedules and improve asset management while ensuring regulatory compliance.

*Anderson Greenwood Series 400 with Monitoring Product information*

### Emissions Reduction Opportunities

Best in class seat tightness (fugitive emissions if venting to atmosphere). Balanced against backpressure with no need for fragile bellows that can create large fugitive emissions concerns. PRV Monitoring can tell you when a valve opened, the timestamp and duration of that event, aid in the calculation of a volumetric release, and even give feedback as to whether a valve is leaking.



# DISTRIBUTION - LNG

- ➔ City Gate / Custody Transfer
- ➔ Meter Applications
- ➔ District Regulator Station
- ➔ Power Plant Feed
- ➔ **LNG**

Natural gas-fired power plants typically source gas from a nearby transmission pipeline which can operate at pressures from 200 psig to over 1000 psig. These high pressures, along with high flow required to feed the plant, require the installation of large, pilot-operated pressure reducing regulators, or control valves at the pressure reduction stations that feed the plant.

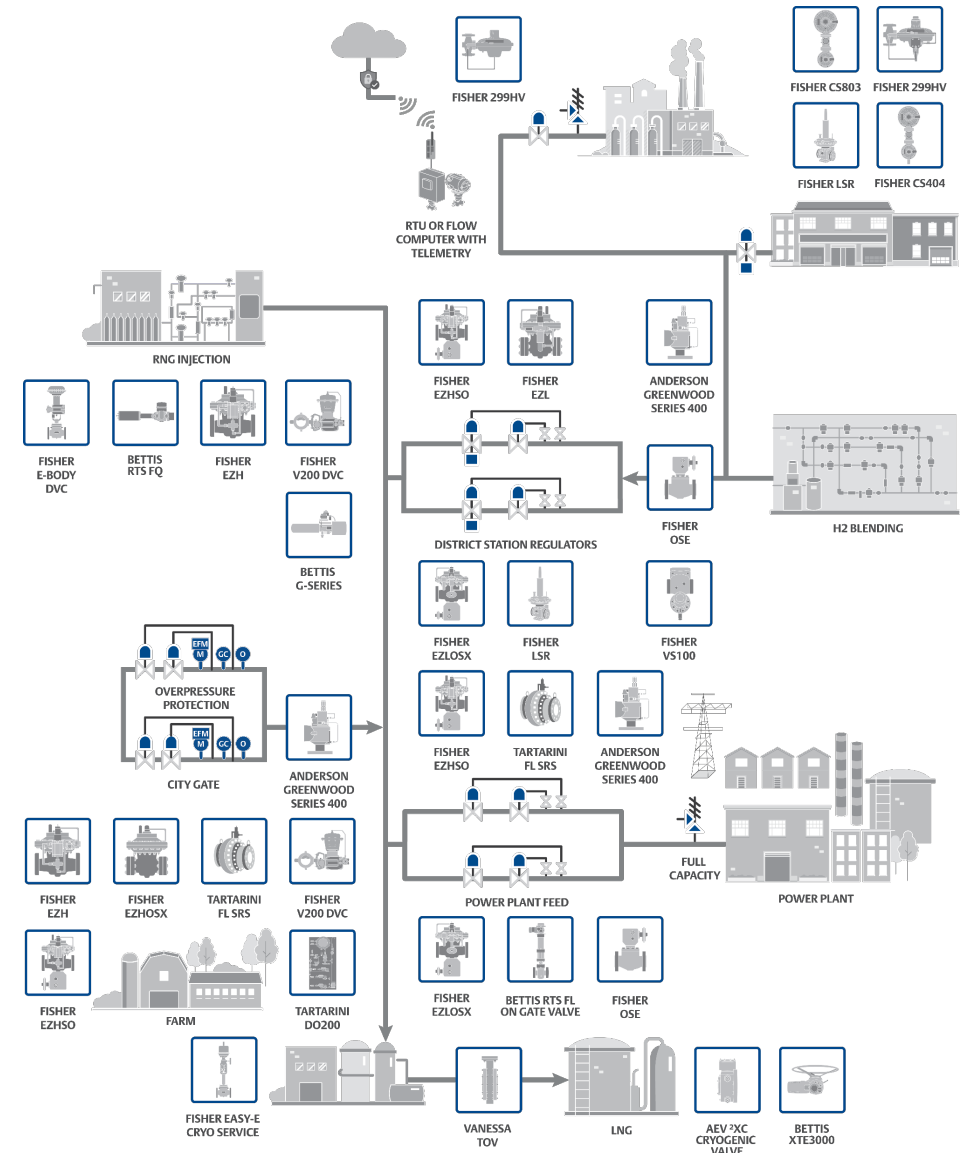

## Solutions

- ➔ Fisher easy-e Cryogenic Control Valve
- ➔ AEV <sup>2</sup>XC Cryogenic C-Ball Valve
- ➔ Vanessa Series 30,000 Triple Offset Valve
- ➔ Bettis XTE3000



## DISTRIBUTION – LNG

- City Gate / Custody Transfer
- Meter Applications
- LNG
- District Regulator Station
- Power Plant Feed

Natural gas-fired power plants typically source gas from a nearby transmission pipeline which can operate at pressures from 200 psig to over 1000 psig. These high pressures, along with high flow required to feed the plant, require the installation of large, pilot-operated pressure reducing regulators, or control valves at the pressure reduction stations that feed the plant.

### Solutions

- Fisher easy-e Cryogenic Control Valve
- AEV <sup>2</sup>XC Cryogenic C-Ball Valve
- Vanessa Series 30,000 Triple Offset Valve
- Bettis XTE3000

### Fisher™ easy-e Cryogenic Control Valve



The Fisher easy-e cryogenic valve is a globe style, single-port, valve featuring stainless steel construction materials and fabricated extension bonnets. These cryogenic valves are designed to provide throttling or on/off control of liquids and gases at cryogenic temperatures as low as -198°C / -325°F. When required, these rugged valves can reliably provide tight shutoff for special applications within the chemical and hydrocarbon processing industries, such as certain liquefied natural gas services. ENVIRO-SEAL™ packing systems provide an improved stem seal to help prevent the loss of process fluid.





*Fisher easy-e Cryogenic Control Valve  
Product information*

### Emissions Reduction Opportunities

ENVIRO-SEAL packing system provides improved sealing, guiding, and transmission of loading force to control liquid and gas emissions.



# DISTRIBUTION – LNG

-  City Gate / Custody Transfer
-  Meter Applications
-  LNG
-  District Regulator Station
-  Power Plant Feed

Natural gas-fired power plants typically source gas from a nearby transmission pipeline which can operate at pressures from 200 psig to over 1000 psig. These high pressures, along with high flow required to feed the plant, require the installation of large, pilot-operated pressure reducing regulators, or control valves at the pressure reduction stations that feed the plant.

## AEV <sup>2</sup>XC™ Cryogenic C-Ball Valve

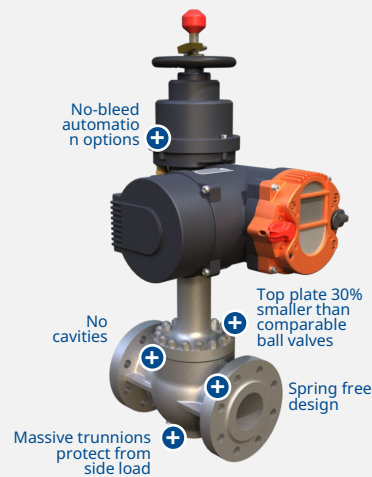

Enabled by a unique “C” ball shape and double eccentric design, the <sup>2</sup>XC ball valve acts along two vectors of movement to allow opening and closing of the valve without friction or wearing at the seat and “C” contact. At close, a zero-leakage metal to metal seal is formed by cam effect, one full order of magnitude greater than the prevailing industry standard (BS6364), assuring an ultra tight mechanical seal.

**AEV <sup>2</sup>XC Cryogenic C-Ball Valve**  
Product information



### Solutions

-  Fisher easy-e Cryogenic Control Valve
-  AEV <sup>2</sup>XC Cryogenic C-Ball Valve
-  Vanessa Series 30,000 Triple Offset Valve
-  Bettis XTE3000

### Emissions Reduction Opportunities

Various packing materials can be configured with live-loading to achieve low emissions to ISO 15848.

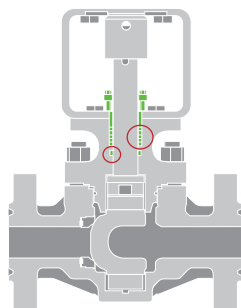

**STEM SEALING**



#### LOW FE CERTIFIED

Futureproof your facility with ISO 15848 certification to stay ahead of fugitive emissions regulation.



#### ZERO LEAKAGE

Mechanical torque seating against a fixed seat for bidirectional zero leakage sealing.







#### REDUCE MAINTENANCE

Massive integral trunnions support ball absorbing any process forces to protect the stem from side load.



# DISTRIBUTION – LNG

-  City Gate / Custody Transfer
-  Meter Applications
-  LNG
-  District Regulator Station
-  Power Plant Feed

Natural gas-fired power plants typically source gas from a nearby transmission pipeline which can operate at pressures from 200 psig to over 1000 psig. These high pressures, along with high flow required to feed the plant, require the installation of large, pilot-operated pressure reducing regulators, or control valves at the pressure reduction stations that feed the plant.

## Vanessa Series 30,000 Triple Offset Valve

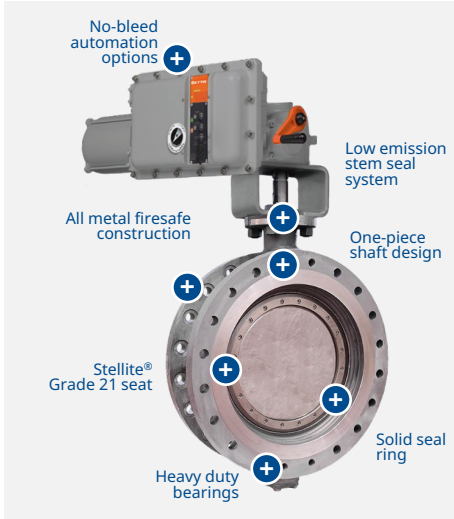

The Vanessa Series 30,000 is a robust triple offset valve featuring an integral-to-body valve seat and optimized seating angles, that enables isolation and process control through multiple functionalities.

*Vanessa Series 30,000 Triple Offset Valve*  
Product information



### Solutions

-  Fisher easy-e Cryogenic Control Valve
-  AEV 2XC Cryogenic C-Ball Valve
-  Vanessa Series 30,000 Triple Offset Valve
-  Bettis XTE3000

### Emissions Reduction Opportunities

External emission risk is minimized by a safer two-piece packing gland and graphite packing.



**STEM SEALING**



**LOW FE CERTIFIED**  
Futureproof your facility with ISO 15848 certification to stay ahead of fugitive emissions regulation.



**ZERO LEAKAGE**  
Achieve torque seated, metal to metal, bidirectional shutoff across a wide pressure & temperature range.



**REDUCE MAINTENANCE**  
Eliminating contact between seat & seal during opening & closing extends the life of the valve.



# DISTRIBUTION – LNG

- City Gate / Custody Transfer
- Meter Applications
- LNG
- District Regulator Station
- Power Plant Feed

Natural gas-fired power plants typically source gas from a nearby transmission pipeline which can operate at pressures from 200 psig to over 1000 psig. These high pressures, along with high flow required to feed the plant, require the installation of large, pilot-operated pressure reducing regulators, or control valves at the pressure reduction stations that feed the plant.

## Solutions

- Fisher easy-e Cryogenic Control Valve
- AEV <sup>2</sup>XC Cryogenic C-Ball Valve
- Vanessa Series 30,000 Triple Offset Valve
- Bettis XTE3000

## Bettis™ XTE3000



The XTE3000 is an intelligent multi-turn electric actuator from the Bettis family of actuators. Specifically designed to meet the most challenging valve automation demands of the Oil and Gas, Power and Process industries, the XTE3000 is compliant with a wide range of international standards and is the ideal solution to your operation’s safety and reliability requirements.

*Bettis XTE3000*  
Product information



## Emissions Reduction Opportunities

XTE3000 Electric actuation in this application will eliminate venting of methane associated with valve operation.



**Realizing the environmental advantages of natural gas as an energy source requires intentional efforts to reduce emissions throughout the value chain.**

**Emerson is your partner for effective and sustainable efforts to reduce emissions, lost product and required maintenance.**