

Converters

General Description

Branson Ultrasonics offers a complete line of converter products for automation and systems builders. The converters are designed to cover a wide range of applications, and when used with the DCX or 2000X power supply, the matched pair provides a robust and high-performing ultrasonic welding system. By emphasizing innovation, reliability, and proven technology, Branson is the world leader in ultrasonic plastics joining.



Multiple Options

Branson offers fourteen converters in three frequencies for optimization. The operating frequencies are 40 kHz, 30 kHz, and 20 kHz, and they cover a power range from 800 W to 4000 W. They can be combined with a horn, booster, and power supply to form an ultrasonic system for continuous-duty or plunge welding.

Robust Construction

To accommodate various environments and applications, the converters are offered in three construction types.

The CR converter is constructed from aluminum and provides an economical solution for most general-purpose applications.

Key Features

- Three frequencies available: 20 kHz at 4 kW max., 30 kHz at 1.5 kW max., and 40 kHz at 0.8 kW max.
- Inlet port for air cooling.
- IP20

The CH converter is constructed from aluminum and has a sealed housing for protection from potentially harmful particles.

Key Features

- Two frequencies available: 20 kHz at 4 kW max. and 30 kHz at 1.5 kW max.
- Inlet and outlet ports for air cooling.
- IP53

The CS converter is constructed from stainless steel and titanium and has a sealed housing for a higher order of environmental protection.

Key Features

- Two frequencies available: 20 kHz at 4 kW max. and 30 kHz at 1.5 kW max.
- Solid mount construction, no O-rings.
- Can be used with or without a booster.
- Inlet and outlet ports for air cooling.
- IP65

Electrical Connections

To accommodate stationary and moving converters, two types of RF electrical connections are offered for all converters. All standard DCX RF cables connect to both types of RF connections.

C-type RF connection

For applications where the converter is moving. The C-type connection is a 3-foot cable hardwired to the converter with a bulkhead SHV connector on the loose end. This connection type is recommended if the converter and stack are in motion.

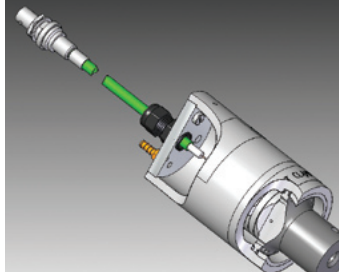

CR construction with C-type RF connection.

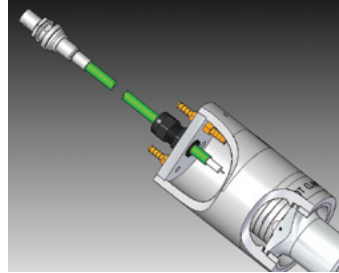

CH construction with C-type RF connection.

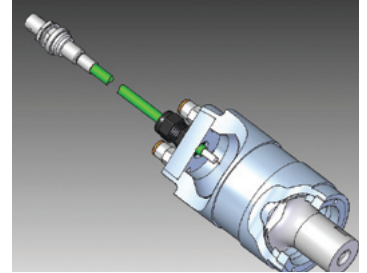

CS construction with C-type RF connection.

S-type RF connection

For applications where the converter is stationary. The S-type connection is an SHV connector located at the top of the converter. This connection type is recommended if the converter and stack are stationary.

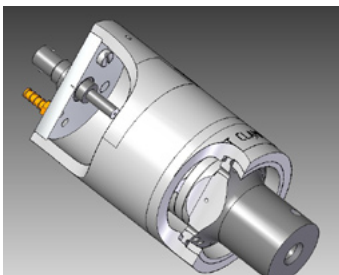

CR construction with S-type RF connection.

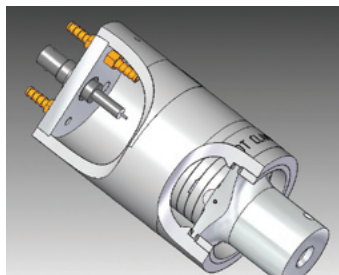

CH construction with S-type RF connection.

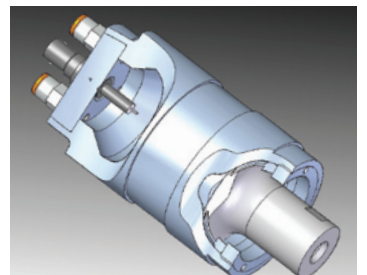

CS construction with S-type RF connection.

Converter Envelope Dimensions

	CR-20	CR-30	CR-40	CH-20	CH-30	CS-20	CS-30
a (inch)	7.89	5.62	4.60	7.89	5.62	8.13	5.65
b (inch)	5.53	3.79	2.88	5.53	3.79	6.51	4.00
c (inch)	1.63	1.19	1.00	1.63	1.19	0.89	0.92
d (inch)	2.97	2.38	1.77	2.97	2.38	3.10	2.38
wt (lbs)	2.91	1.30	0.66	3.42	1.46	7.98	3.12
a (mm)	200.4	142.7	116.8	200.4	142.7	206.5	143.5
b (mm)	140.5	96.3	73.2	140.5	96.3	165.4	101.6
c (mm)	41.4	30.2	25.4	41.4	30.2	22.6	23.4
d (mm)	75.4	60.5	45.0	75.4	60.5	78.7	60.5
wt (kg)	1.32	.59	.30	1.55	.66	3.62	1.41
Cooling Air Tube	x	y	w	z	y	x	x

Legend: w = 1/16 inch ID tube x = 6 mm OD tube y = 1/8 inch ID tube z = 5/32 inch ID tube

CR and CH converter envelope
(S-type RF connection shown).

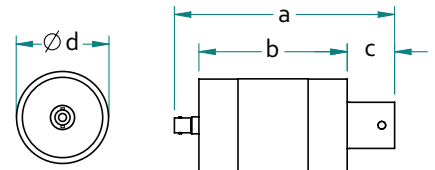

CS converter envelope
(S-type RF connection shown).

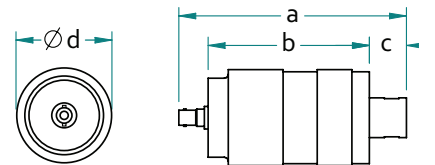

Ordering Information

Note: All sales shall be subject to the Supplier's terms and conditions of sale as described in Branson's quotations and sales contracts.

CR Converters

Frequency	RF Connection	Description	Branson EDP No.
20 kHz	S	CR-20S	125-135-115R
30 kHz	S	CR-30S	101-135-081R
40 kHz	S	CR-40S	101-135-067R
20 kHz	C	CR-20C	159-135-210R
30 kHz	C	CR-30C	159-135-213R
40 kHz	C	CR-40C	159-135-215R

CH Converters

Frequency	RF Connection	Description	Branson EDP No.
20 kHz	S	CH-20S	159-135-075R
30 kHz	S	CH-30S	101-135-071R
20 kHz	C	CH-20C	159-135-211R
30 kHz	C	CH-30C	159-135-214R

CS Converters

Frequency	RF Connection	Description	Branson EDP No.
20 kHz	S	CS-20S	159-135-138R
30 kHz	S	CS-30S	159-135-110R
20 kHz	C	CS-20C	159-135-209R
30 kHz	C	CS-30C	159-135-212R

Ordering Key

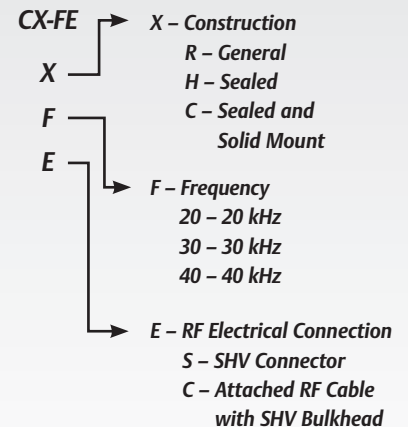

True Global Support & Service

Branson Ultrasonics is the world leader in materials joining with more than 1,800 employees and 70 sales and support offices. We are committed to leading the industry in products, solutions, service and support excellence. That means fast delivery, troubleshooting, parts replacement, feasibility studies, cooperative research, preventative maintenance and repair services. Branson is part of the Industrial Automation division of Emerson, a diversified international manufacturing and technology company committed to developing technological breakthroughs that advance the performance of a wide range of products and processes.

All specifications subject to change without notice. All dimensions are nominal.
All units are CE compliant and comply with FCC rules and regulations governing radio frequency interference.



Americas

Branson Ultrasonics Corp.
41 Eagle Road
Danbury, CT 06810, USA
T: 203-796-0400
F: 203-796-0450
www.bransonultrasonics.com

Europe

Branson Ultraschall
Niederlassung der Emerson
Technologies GmbH & Co. OHG
Waldstrasse 53-55
63128 Dietzenbach, Germany
T: +49-6074-497-0
F: +49-6074-497-199
www.branson.eu

Asia

Branson Ultrasonics (Shanghai) Co., Ltd.
758 Rong Le Dong Road
Song Jiang, Shanghai, PRC, 201613
T: 86-21-3781-0588
F: 86-21-5774-5100
www.branson.com.cn