

# Optimize Energy Use in Distillation

**DOUGLAS C. WHITE**  
EMERSON PROCESS MANAGEMENT

Nonlinearities in the response of a column to changes in operating conditions and in common economic valuation functions can have significant impacts on the economic optimum energy consumption for the column. Here's a way to account for such nonlinearities.

The U.S. Dept. of Energy estimates that there are more than 40,000 distillation columns in North America, and that they consume about 40% of the total energy used to operate plants in the refining and bulk chemical industries (1). Improving the energy efficiency of this unit operation, therefore, is important to achieving overall plant energy savings.

Reducing the energy consumption of distillation columns is not straightforward. First, columns come in many configurations with different operating objectives. These differences lead to distinct dynamic behaviors and different operational degrees of freedom, which necessitate specialized control configurations to optimize energy usage. In addition, many columns are subject to significant interaction among the control loops and have numerous constraints or limits on their operation, further complicating the dynamics and making it even more difficult to optimize control.

The operation of distillation columns typically involves a tradeoff between energy usage and product recovery, and setting the proper target involves evaluating the relative economic value of these two factors. However, distillation is a nonlinear process, and normal product-valuation patterns add more nonlinearity to the economic objective function. Thus, calculating the correct operational targets can be complicated.

Many books and papers have been published on advanced control of distillation columns and the design and analysis of these controls (2-4);

the book by Blevins, *et al.* (2) provides a good introduction to the topic. This article discusses the nonlinear economic aspects of distillation control optimization and demonstrates a technique for calculating the correct energy-usage targets.

## Recapping column basics

A two-product trayed column with typical controls is shown in Figure 1. The column separates the feed into two products, at least one of which is subject to a specification

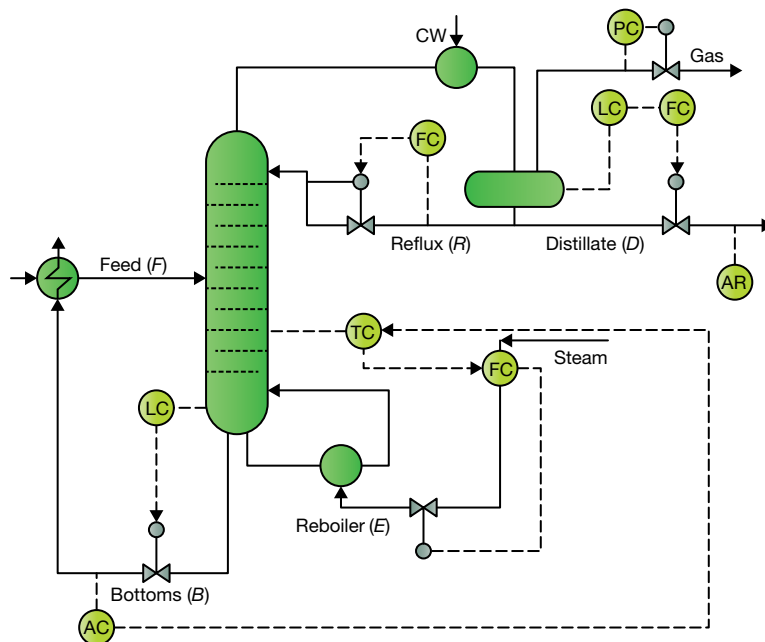

▲ Figure 1. A distillation column is often controlled based on reboiler duty and reflux rate.

# Reactions and Separations

limiting the amount of impurities it may contain. At a fixed feed rate and pressure, the two major variables that can be manipulated to regulate the column are the reboiler duty ( $E$ ), which may be controlled by a temperature controller, and the reflux rate ( $R$ ). In some cases, depending on the feed rate and composition, as well as the specific impurity targets for a particular column, there may be no feasible set of reflux and reboiler targets that meet the operating objectives, there may be one feasible set of targets, or there may be a region of operation with multiple targets that allow the column to produce on-spec material.

The steady-state equations governing simple binary distillation are the overall material balance (Eq. 1) and the component  $i$  material balance (Eq. 2):

$$F = B + D \quad (1)$$

$$Fx_{Fi} = Bx_{Bi} + Dx_{Di} \quad (2)$$

where  $F$ ,  $B$ , and  $D$  are the feed, bottoms, and distillate flow-rates, and  $x$  is the mole fraction of component  $i$  in the stream.

From these equations, the following relationship can be derived:

$$B/F = (x_{Fi} - x_{Di}) / (x_{Bi} - x_{Di}) \quad (3)$$

The light ( $l$ ) and heavy ( $h$ ) key components are the components with close boiling points that the column is designed to separate. For example, in a light hydrocarbon debutanizer, they are typically butane and pentane.

The separation factor,  $S$ , is defined as the ratio of the light-key component fraction to the heavy-key component fraction in the distillate divided by the same ratio in the bottom product:

$$S = (x_{Dl}/x_{Dh}) / (x_{Bl}/x_{Bh}) \quad (4)$$

If the value of the separation factor for all components is known, then the steady-state material balance equations can be solved, which in turn defines the column's performance.

The separation factor for a given column and feed component mix is a function of energy input — as the reflux and energy input increase, the separation factor increases. For a

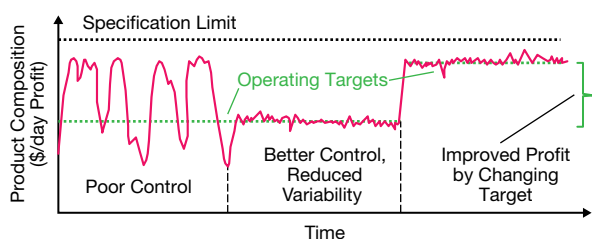

▲ **Figure 2.** Improved control usually reduces variability in the controlled variable, allowing the operating target to be moved closer to its limit.

binary distillation with constant relative volatility and total reflux, the limiting-case analytical solution for calculating the minimum number of theoretical trays is known as the Fenske equation (5). For multicomponent distillation, empirical rules may be used to calculate the separation factor(s), although the more common approach today is to perform a detailed tray-to-tray distillation simulation.

This article is based on column simulations performed using Version 6.5.1 of ChemSep ([www.chemsep.com](http://www.chemsep.com)), with the Peng-Robinson equation of state for the thermodynamic properties and ideal enthalpies corrected via the “excess” option. The column was assumed to have 10 ideal stages with the feed on Stage 5. The feed was assumed to be equal molar quantities of propane, butane, pentane, and hexane.

## Economic valuation of control improvements

The following procedure is commonly used to analyze the economic benefits of improved control, such as multivariable control or improved online measurements. The variability of the controlled variable is first analyzed under normal operating conditions (Figure 2, left). The initial operating target for the controlled variable is set at a conservative distance from its specification limit. This limit usually relates to a physical limit in the plant, such as a maximum temperature or maximum valve opening, or to a product quality specification. Next, new instrumentation or control technology is introduced, which should reduce the variability of the controlled variable (Figure 2, center). The operating target can then be moved closer to the specification limit (Figure 2, right). Generally, the new operating target is more economically advantageous than the old one, and the economic difference is projected as the value of the improved control.

The quantitative economic evaluation starts with a statistical analysis of the current variability of the process variable of interest. This usually involves converting the time series data (Figure 3a) to a curve (Figure 3b) representing the relative frequency of occurrence of the variable of interest; this curve is called the probability distribution function

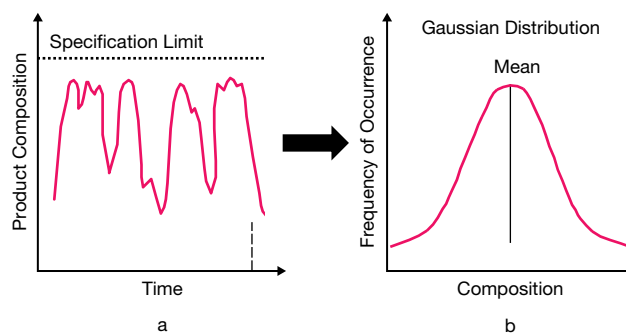

▲ **Figure 3.** The time-series composition data (a) are converted to a frequency of occurrence (b), or probability distribution function (PDF).

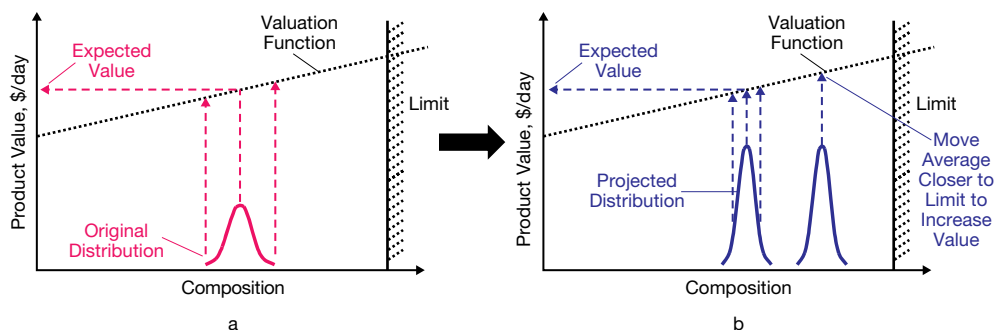

▲ **Figure 4.** The economic value of the product is plotted as a function of the process variable of interest for the base case (a) and the improved-control case (b).

(PDF). In many cases, the data are assumed to be adequately represented by the normal (Gaussian) statistical distribution, which simplifies the subsequent calculations.

To calculate the overall economic value of improved control, one must assign economic value as a function of the variable of interest (Figure 4). The economic value function for a distillation column might be the operating margin (product value minus feed cost minus energy cost) at the required separation. Here, the variable is composition and the valuation function increases linearly with this variable.

The economic value plotted in Figure 4a is calculated by projecting each point in the base-case PDF (Figure 3b) to its corresponding point in the valuation function. The mean, or expected overall economic value, is calculated by weighting — *i.e.*, by multiplying the individual economic values by their frequency of occurrence (which is the PDF value at that point). The statistical distribution under improved control is estimated in the same way and the expected economic value for the new distribution is then calculated (Figure 4b).

One often-overlooked conclusion is that if the process data have a Gaussian distribution and the economic valuation function is linear, there is no change in the economic

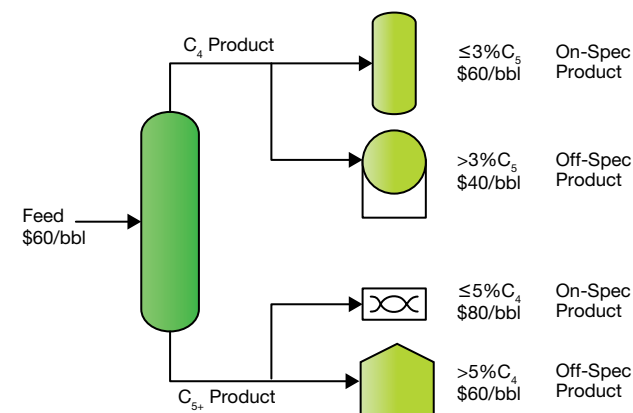

▲ **Figure 5.** The column's top and bottom streams have tiered pricing whereby off-spec material has a lower value than product that meets specifications.

value if the mean is constant — that is, a reduction in standard deviation has no direct economic impact. Since the distribution is symmetric, the loss from negative deviations is exactly offset by the gain from positive deviations.

The improved economic value comes from moving the average operating point in the direction of higher economic value. This usually

involves moving closer to an operating limit, with the new target chosen based on an acceptable probability of violating the limit. The new operating point has a higher expected economic value; the difference between this higher value and the base-case value is the value of the improved control (Figure 4b). Under these assumptions, the most profitable operating point is the one closest to the limit that does not result in economically significant off-spec product. Reference 6 presents the equations for the change in expected profit when the target is moved closer to the limit if there is a linear objective function and Gaussian variable distributions.

While this analysis is correct, it does not consider some economic effects that could come into play as a result of nonlinearities. This article reviews some of these issues and discusses how they can be evaluated. Reference 7 analyzes and presents equations for the case where the objective function is quadratic and the variable distribution is Gaussian.

## Case study

The economic valuation methodology will be demonstrated through a specific case study. The column depicted in Figure 5 has the feed and product characteristics listed in Table 1. Note that both products have tiered, discontinuous pricing: product within specification has one value, while out-of-specification product has a different, lower

Table 1. Data for the case study.		
Stream	Composition/ Specification	Value
Feed, 20,000 bbl/d	25% C <sub>3</sub>	\$60/bbl
	25% nC <sub>4</sub>	
	25% nC <sub>5</sub>	
	25% nC <sub>6</sub>	
Bottoms Product = C <sub>5</sub>	≤5% C <sub>4</sub>	\$80/bbl
	>5% C <sub>4</sub>	\$60/bbl
Top Product = C <sub>4</sub>	≤3% C <sub>5</sub>	\$60/bbl
	>3% C <sub>5</sub>	\$40/bbl
Steam		\$15/MBtu

## Reactions and Separations

value. (This is very common for most unit operations, not just distillation.)

If the top product (the light key), butane, is within specification (*i.e.*,  $\leq 3\% C_5$ ), it is fed to a downstream unit for further processing and eventual sale. Off-specification butane goes to a tank and may be reprocessed or used as fuel (which is of lower value). Similarly, the bottom product (heavy key), pentane, is used in another part of the plant or fed to a pipeline to produce a higher-value product if it meets specifications ( $\leq 5\% C_4$ ), and off-specification pentane may be sent to a tank for reprocessing.

### Setting operating targets

To choose the bottoms temperature setpoint, first assume that the reflux rate is fixed, and that the bottom product is on-spec but the top product is off-spec because of its high pentane content. This would correspond to a very high bottoms temperature. Next assume that the bottoms temperature

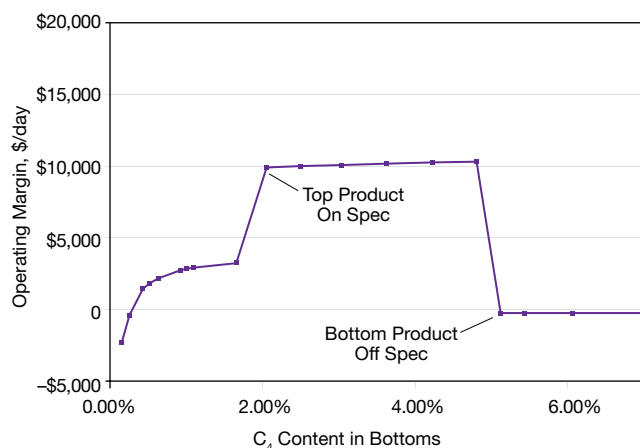

▲ **Figure 6.** Operating margin is a function of the bottoms composition (*i.e.*, butane content).

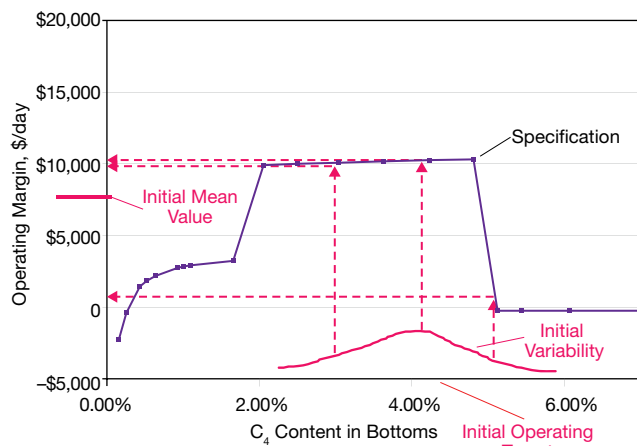

▲ **Figure 7.** The mean product value does not correspond to the value at the mean of the product compositions.

target is slowly reduced. Figure 6 plots the operating margin for the column based on the assumed prices in Table 1. As the temperature is reduced, the amount of bottom product increases and the percentage of top product (butane) in the bottom stream also increases. As the amount of pentane (the more-valuable bottom product) increases, the total product value increases.

The economic value function contains two discontinuities. The first, which occurs when the composition of the bottom product is about 1.0% butane, corresponds to a change in the top product from off-spec to on-spec. The second discontinuity occurs when the bottom product becomes off-spec at 5% butane.

Normally one would select a temperature target such that the bottoms composition is as close to the specification limit as possible. There will always be some variability in the control performance due to external disturbances and limitations on loop control action. If composition control is poor and highly variable, the observed composition probability distribution function might have the shape labeled Initial Variability in Figure 7. The product composition target is the mean value of the PDF.

The mean value of the operating margin is calculated based on the weighted average composition of the initial distribution — *i.e.*, the percentage at each composition is multiplied by the margin value at that composition to determine the overall value. Figure 7 shows the projected initial mean value of the operating margin for a case where variability in control results in some of the bottom product being off-specification with lower value. The mean product value does not correspond to the value at the mean of the product compositions (which is also the operating target). This is because of the nonsymmetrical nature of the objective function and the low value of off-spec material.

It may be possible to reduce the variability through

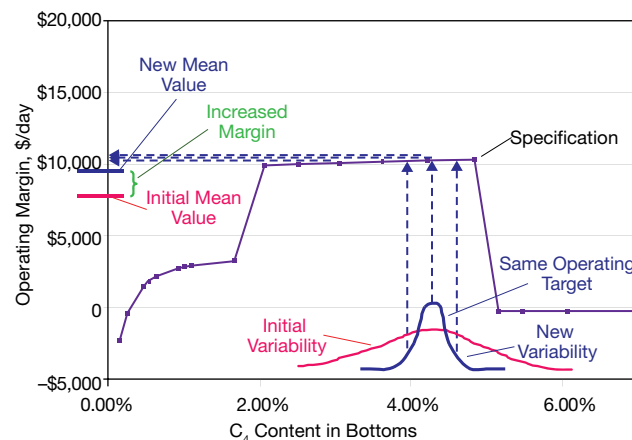

▲ **Figure 8.** Reducing variability in control increases the operating margin.

improved control-valve performance, reduced measurement error, or advanced control functionality. With reduced variability, the projected new mean value of the operating margin would be higher at the same operating target (Figure 8). Here, reduced variability at the same average bottoms composition results in an increase in the overall mean operating margin due to the nonlinearity of the economic valuation function.

The mean product value can be increased further by moving the operating target closer to the specification. A seldom-noted characteristic of this type of nonlinear economic valuation function is an optimum target that maximizes profitability for any given control variability (*i.e.*, standard deviation) that is not at the specification limit. As the target is moved closer to the specification, the value of on-spec material increases, but the amount of low-value off-spec material also increases. There is a point at which the marginal increase in the value of on-spec material just equals the decrease in the value of off-spec material. This is the optimum target.

Figure 9 shows the operating margin as a function of bottoms composition setpoint for the case study. An optimum setpoint exists for each assumed standard deviation. Hence, reduced variability enables the process to move to an optimum setpoint of higher economic value.

In other words, it may be more profitable to operate the column with a product that is of higher purity than is required by the specification, rather than one that just meets the specification.

### Energy usage analysis

The preceding discussion involved constant-reflux operation (Figure 9). Next consider the situation where the reflux is varied and the bottoms composition is constant. As the reflux flow is increased, the cost of energy for the separation increases approximately linearly (Figure 10). The separation improves, the amount of heavy material in the overhead

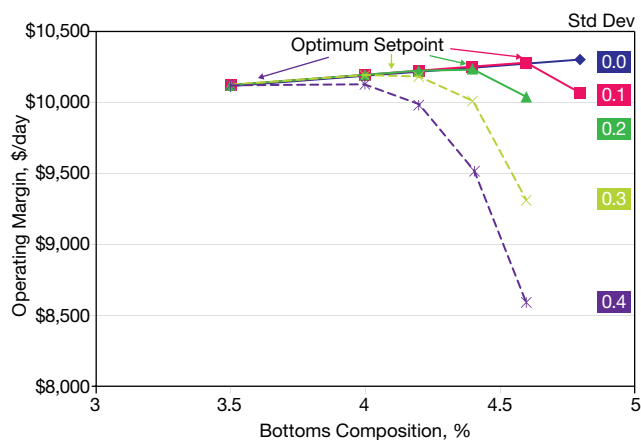

▲ **Figure 9.** The optimum setpoint depends on the amount of variability in control.

decreases, and the amount of bottom product increases correspondingly. However, this increase is not linear — as shown in Figure 10, continuing to increase the reflux has a diminishingly smaller effect on the compositions.

Figure 11 shows the operating margin (*i.e.*, the difference between the value of the product and the total cost of the feed and energy) for different energy prices, assuming constant product prices. Notice the optimum reflux value, which depends on the price of energy. At a high energy price, the optimum reflux is the minimum value that just allows the column to maintain the top product in specification. At lower energy prices, the optimum reflux is actually unconstrained.

The conclusion — that operating targets should be a function of energy costs rather than a fixed number, even with fixed compositional limits — does not seem to be widely recognized. It is common to find distillation columns operating at reflux rates that are 50% higher than optimum. For the case study presented here, such an operation could result in a loss of operating margin in excess of \$500,000/yr.

*Article continues on next page*

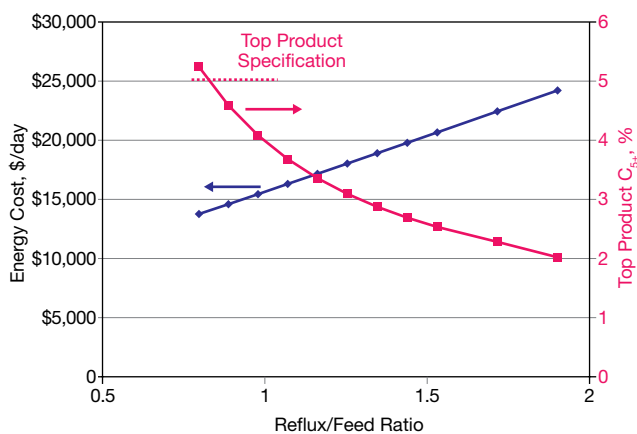

▲ **Figure 10.** As reflux increases, energy cost increases approximately linearly, and the amount of heavy component in the top product decreases.

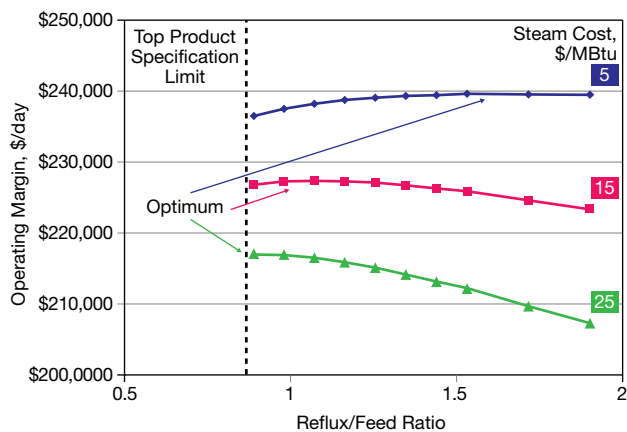

▲ **Figure 11.** The optimum reflux depends on the price of energy.



## Reactions and Separations

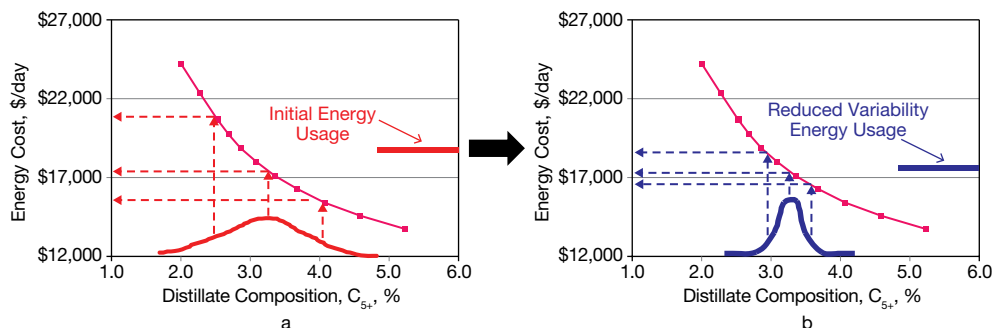

◀ **Figure 12.** Tighter control of the process reduces the variability in distillate composition and in energy usage.

### The impact of control variability on energy consumption

Assume that an optimum target for the impurities in the distillate has been calculated and implemented. Figure 12, a plot of energy cost vs. overhead distillate composition at a fixed bottoms composition, illustrates the impacts of better control on energy usage. A mean energy usage value can be calculated by projecting each point of the PDF to the energy usage curve. Note that here, too, the expected value of the objective function (*i.e.*, the economic valuation function) does not correspond to the value of the objective function at the mean of the distribution. Figure 12a shows the mean energy usage with the initial, more-variable control. With better control performance and less variability, the PDF is tighter, as shown in Figure 12b. The mean energy usage value of this PDF, at the same mean composition, is lower.

Better control and reduced variability, without any change in mean product composition, reduces energy consumption, unlike the result for a linear objective function. Figure 13, a plot of the expected energy usage as a function of control performance standard deviation for the case study, shows the impact of reduced control variability on energy cost.

It is sometimes stated that precise control of column composition is not required because the product is going to a tank and the important composition is the final blended composition in the tank. However, blending does not change the result demonstrated here — improved control leads to lower overall energy usage even at the same mean composition.

### Operating pressure effects on energy usage

It is generally known that reducing the operating pressure of light-hydrocarbon distillation columns reduces energy consumption. Yet, many such columns are commonly operated well above their potential minimum pressures.

During the design phase, the minimum required operating pressure of a conventional column configuration is normally based on the heat-transfer medium used in the condenser — the maximum condenser operating temperature is estimated based on the medium, and from this the pressure required for the target degree of condensation of the desired components can be calculated. For example, if air cooling

is employed, the maximum expected ambient-air temperature plus an approach ( $\Delta$ ) temperature allowance is used to set the design condenser temperature, which fixes the design pressure. It is also necessary to make sure that at the design pressure there is a sufficient differential between the temperatures of the reboiler heating medium and the bottoms material for effective heat transfer.

However, for most columns in actual operation, the minimum pressure limits vary with feed rate, time of day, and other conditions in the plant. For the pressure control configuration shown in Figure 1, a common limit is the valve position in the control loop. The pressure should be reduced to the point that the valve is almost fully open but still in a controllable range, and then varied to maintain the valve in the desired position (as discussed in Ref. 6). There may be multiple other operating limits on the minimum pressure, and control constraint logic (*e.g.*, multivariable control algorithms) can be used to select the most limiting.

One might ask: If the control objective is well known,

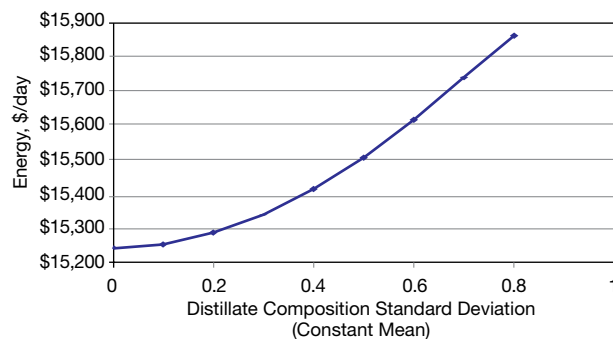

▲ **Figure 13.** Control variability increases energy costs.

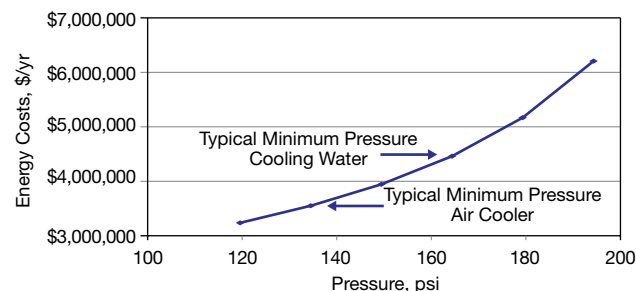

▲ **Figure 14.** Reducing column operating pressure has a significant impact on energy costs.

why is it not more widely implemented? There appear to be three primary reasons for this.

First, changing the pressure requires simultaneously changing the bottoms temperature setpoint appropriately to hold the product compositions at their targets. This is difficult to do manually — advanced composition control on the column is required.

Second, changes in column pressure have other impacts on the plant, such as changes in the offgas rate (which affects the downstream gas processing), the amount of reboiler heating medium needed, and the hydraulic profile of the plant. In the case of partial condensation, pressure control can interact with the overhead receiver level. While these effects are real, their magnitude is sometimes exaggerated and cited as reasons for not making any changes.

Finally, plant personnel frequently do not agree on the amount of operating margin required to handle major disturbances. For instance, questions often arise about the dynamic response of an air-cooled condenser to a rainstorm and the ability of the overall control system to handle such conditions. A well-designed overall control system for the column can compensate for such disturbances.

Figure 14 shows the impact of reducing pressure on overall energy costs (at constant separation) for the case study considered in this article. Note that it is substantial. Even a reduction of 10 psi in the average operating pressure, which is less than a 7% change, would result in energy savings in excess of \$240,000/yr.

Figure 14 also shows the impact of choosing a condenser medium with a lower temperature — for example, by adding a supplemental cooling water condenser to an existing overhead system initially built with air coolers. The benefits would be expected to exceed \$600,000/yr and the payout for such a project would be very rapid.

One concern is that lowering pressure could move the column closer to flooding, since the volumetric equivalent of a unit molar vapor flow will increase at lower pressure. However, the required total molar vapor flow at constant product composition decreases with the reduced energy input, and this decrease typically more than offsets the unit volumetric increase. A rigorous tray-to-tray simulation can quantify the expected tradeoffs and should be routinely used when making these decisions on operating columns.

For packed columns, pressure changes can impact the mass-transfer coefficients, and these changes need to be evaluated as part of any energy-reduction evaluation.

## Wrapping up

An often-overlooked point is that if the controlled-variable process data have a Gaussian distribution and the economic valuation function (as a function of the controlled variable) is linear, improved control will not change the economic value if the mean of the observed controlled-variable process values is constant. In other words, a reduction in standard deviation has no direct economic impact. Changing the controlled-variable target in the direction of increased profitability is required.

That is not the case when the economic valuation is nonlinear. If it is a step function (as in the case study discussed here), then the optimum target that maximizes profitability depends on the control variance achieved. A reduction in the standard deviation of control can have a positive impact on the expected operating margin of the column.

The optimum reflux depends on the energy price and the composition targets. If the energy price is high, the optimum reflux is the minimum that just allows the column to maintain both products in specification. However, if the energy price is lower, the optimum is actually unconstrained. It may be more profitable to operate the column at impurity levels less than the actual limit.

Reducing pressure can have a significant impact on overall energy costs at constant separation. The impact should be checked first by simulation, and then pressure-reduction control strategies can be implemented.

CEP

## LITERATURE CITED

1. **U.S. Dept. of Energy, Office of Energy Efficiency and Renewable Energy**, "Distillation Column Modeling Tools," DOE, Washington, DC, [http://www1.eere.energy.gov/manufacturing/industries\\_technologies/chemicals/pdfs/distillation.pdf](http://www1.eere.energy.gov/manufacturing/industries_technologies/chemicals/pdfs/distillation.pdf).
2. **Blevins, T. L., et al.**, "Advanced Control Unleashed," International Society for Automation (ISA), Research Triangle Park, NC (2003).
3. **Luben, W., ed.**, "Practical Distillation Control," Van Nostrand Reinhold, New York, NY (1992).
4. **Shinskey, F. G.**, "Distillation Control, McGraw-Hill, New York, NY (1984).
5. **Shinskey, F. G.**, "Energy Conservation Through Control," Academic Press, New York, NY (1978).
6. **Muske, K. R.**, "Estimating the Economic Benefit from Improved Process Control," *Ind. Eng. Chem. Res.*, **42** (20), pp. 4235–4544 (2003).
7. **Stout, T. M., and R. P. Cline**, "Control System Justification," *Instrumentation Technology*, **9** (23), pp. 51–58 (Sept. 1976).

**DOUGLAS C. WHITE** is the Director of Refining Industry Solutions, and a Senior Principal Consultant for the PlantWeb Solutions Group of Emerson Process Management (12603 Southwest Freeway, Suite 100, Stafford, TX 77477; Phone: (713) 529-5980; Email: [doug.white@emerson.com](mailto:doug.white@emerson.com)). Previously, he held senior management and technical positions with MDC Technology, Profitpoint Solutions, Aspen Technology, and Setpoint. In these positions, he was responsible for justifying, developing, and implementing state-of-the-art, advanced energy automation and optimization systems in process plants around the world. White has published more than 50 technical papers on these subjects. He started his career with Caltex Petroleum Corp., in its Australian Refinery and Central Engineering Groups. He has a BS from the Univ. of Florida, an MS from California Institute of Technology, and an MA and PhD from Princeton Univ., all in chemical engineering. He is a long-time member of AIChE and received the Fuels and Petrochemical Div. Award in 2009.